

2N[®] Indoor Touch 2.0 User Manual



Content:

- 1. Product Overview
 - 1.1 Product Description
 - 1.2 Differences between Models
 - 1.3 Terms and Symbols
 - 1.4 Safety Precautions
- 2. Description and Installation
 - 2.1 Before You Start
 - 2.2 Brief Installation Guide
 - 2.3 Installation Conditions
 - 2.4 Status LED
 - 2.5 First Startup
- 3. 2N® Indoor Touch 2.0 Configuration
 - 3.1 Factory Reset
 - 3.2 Home Screen
 - 3.3 Device Configuration
 - 3.3.1 User Settings
 - 3.3.1.1 Device
 - 3.3.1.2 Personal
 - 3.3.1.2.1 Security
 - 3.3.1.2.2 Language and Input Methods
 - 3.3.1.3 System
 - 3.3.1.3.1 Date & Time
 - 3.3.1.3.2 Restart and Factory Reset
 - 3.3.1.3.3 Firmware Upgrade
 - 3.3.2 Administrator Settings
 - 3.3.2.1 Device
 - 3.3.2.1.1 2N® Meeting Room App
 - 3.3.2.2 Wireless & Networks
 - 3.3.2.3 Security
 - 3.3.2.4 Language & input
 - 3.3.3 Intercoms
 - 3.3.3.1 General Settings
 - 3.3.3.2 Call Settings
 - 3.3.3.3 My2N/SIP Configuration
 - 3.3.3.4 Video
 - 3.3.3.5 Recorder
 - 3.3.3.6 Input and Output
 - 3.4 Device Upgrade
- 4. Intercoms Applications Configuration
 - 4.1 Application Description
 - 4.2 Application Environment and Configuration
 - 4.2.1 Device

- 4.2.2 Call Log
 - 4.2.3 Dial Pad
 - 4.2.4 Settings
 - 4.3 Notifications in 2N® Indoor Touch Environment
 - 4.4 Application Use
 - 4.4.1 LAN Calls
 - 4.4.2 SIP Proxy Server Calls
 - 4.4.3 2N® Mobile Video Calls
 - 4.5 Supplementary Information
 - 4.5.1 Troubleshooting
- 5. Web Interface Configuration
 - 5.1 Login
 - 5.2 System Info
 - 5.2.1 Status
 - 5.3 Device
 - 5.3.1 Network
 - 5.3.2 Home Screen
 - 5.3.3 Local Settings
 - 5.3.4 Display
 - 5.3.5 Audio
 - 5.3.6 System Administration
 - 5.4 Application
 - 5.4.1 Intercoms
 - 5.4.2 Settings
 - 5.5 Limitations
- 6. Maintenance - Cleaning
- 7. Technical Parameters
 - 7.1 General drawings
- 8. Supplementary Information
 - 8.1 Troubleshooting
 - 8.2 Directives, Laws and Regulations - General Instructions and Cautions
 - 8.3 Other Countries' Legislation

1. Product Overview

In this section, we introduce the **2N® Indoor Touch 2.0** product, outline its application options and highlight the advantages following from its use. The section also includes safety precautions.

Here is what you can find in this section:

- [1.1 Product Description](#)
- [1.2 Differences between Models](#)
- [1.3 Terms and Symbols](#)
- [1.4 Safety Precautions](#)

1.1 Product Description

Based on the Android OS, **2N® Indoor Touch 2.0** helps load third party applications to a device (if enabled so in the device configuration), thus improving its flexibility. It contains a 7" colour LCD display with a capacitive touch layer, loudspeaker, microphone and Ethernet and WiFi interfaces (depending on the Part No.) for LAN connection. Analogue inputs and outputs are also part of the equipment.

2N® Indoor Touch 2.0 has a factory pre-installed application – **2N® IP Mobile**, which helps establish video calls with any other video call supporting devices (SIP + H.263/4). Primarily, the application is intended for the **2N IP intercom** family.

2N® Indoor Touch 2.0 contains a specific user interface for an increased user comfort and safety.



2N® Indoor Touch 2.0 basic features:

- 7" LCD colour display with capacitive touch layer
- Wall mounting option
- LAN interface with PoE supply option
- 802.11bgn WiFi interface (depending on the Part No.)
- Status RGB LED at front
- Binary inputs and outputs for control of other devices
- Android operating system with pre-installed basic applications and own user interface
- Pre-installed **2N® IP Mobile** application



1.2 Differences between Models

This manual is valid for all the **2N® Indoor Touch 2.0** types. Therefore, please note that several features described in this document are only available in selected models or need to be activated with a licence key. If a feature is not available in all the models, a note is added to the respective subsection.

2N® Indoor Touch Types 2.0

<p>2N Part Nos.: 91378375 91378376</p> <p>Axis part Nos.: 01668-001 01670-001</p> 	<ul style="list-style-type: none">• 2N® Indoor Touch 2.0 – black• WiFi version (lower Part No.)
<p>2N Part Nos.: 91378375WH 91378376WH</p> <p>Axis part Nos.: 01669-001 01671-001</p> 	<ul style="list-style-type: none">• 2N® Indoor Touch 2.0 – white• WiFi version (lower Part No.)

Accessories

<p>2N Part No. 91378382</p> <p>Axis Part No. 01425-001</p>  A black desk stand with a rectangular top and a base that folds out to support the top at an angle. It has a metal frame with a central horizontal bar and two vertical supports.	<ul style="list-style-type: none">• 2N® Indoor Touch desk stand black
<p>2N Part No. 91378382W</p> <p>Axis Part No. 01426-001</p>  A white desk stand, identical in design to the black one, with a rectangular top and a base that folds out to support the top at an angle. It has a metal frame with a central horizontal bar and two vertical supports.	<ul style="list-style-type: none">• 2N® Indoor Touch desk stand white

<p>Part Nos.: 91378381E 91378381GB 91378381US</p> 	<ul style="list-style-type: none"> • The exclusive type of power adapter SYS1561-0912 to be used with all 2N® Indoor Touch 2.0 devices. • Stabilised 12 V / 0,75 A source to be used where PoE supply is unavailable. • The part numbers differ in their electric socket markings (E/GB/US).
--	---

Licence

Part No.	Description
<p>2N Part No. 91378395</p> <p>Axis Part No. 01424-001</p>	<p>HTTP API – the licence unlocks the HTTP API functions</p>
<p>2N Part No. 91378396</p> <p>Axis Part No. 02171-001</p>	<p>2N® Indoor Touch 2.0 Meeting Room license</p>

1.3 Terms and Symbols

The following symbols and pictograms are used in the manual:

 **Safety**

- **Always abide** by this information to prevent persons from injury.

 **Warning**

- **Always abide** by this information to prevent damage to the device.

 **Caution**

- **Important information** for system functionality.

 **Tip**

- **Useful information** for quick and efficient functionality.

 **Note**

- Routines or advice for efficient use of the device.

1.4 Safety Precautions

The manufacturer reserves the right to modify the product in order to improve its qualities. The manufacturer continuously responds to the clients' requirements by improving the software. Refer to the www.2n.cz company websites for the latest **2N® Indoor Touch 2.0** firmware and User Manual.

- It is prohibited to use any transmitters, including **2N® Indoor Touch 2.0** with an internal WiFi adapter, in areas where explosives are used, such as quarries.
- WiFi adapters may affect sensitive life-saving devices in medical centres. Therefore, it is prohibited to use device with an internal WiFi adapter in such facilities.
- In general, any RF energy radiation prohibition regarding WiFi antenna equipped devices applies to device with an internal WiFi adapter.
- Where necessary, a device unit can be installed at a safe distance from the prohibited area and an Ethernet cable can only be carried to the required site.
- Although the device is not intended for cars or aeroplanes, all prohibitions and regulations relating to adapter equipped devices apply to device too.

2. Description and Installation

This section describes the **2N® Indoor Touch 2.0** installation and correct connection.

Here is what you can find in this section:

- [2.1 Before You Start](#)
- [2.2 Brief Installation Guide](#)
- [2.3 Installation Conditions](#)
- [2.4 Status LED](#)
- [2.5 First Startup](#)

The device is designed solely for wall mounting. Install the device with the aid of a holder, which is included in the product and Installation Manual delivery.

Prepare the proper wall fittings (screws and wall plugs suitable for the given wall type and structure). Respect the local standards for installation of electronic devices onto flammable materials while mounting!

Use a cross-point screwdriver for tightening the fitting screws on the device sides to place **2N® Indoor Touch 2.0** properly.

2.1 Before You Start

Product Completeness Check

Please check the **2N® Indoor Touch 2.0** delivery before starting installation:

1	2N® Indoor Touch 2.0
1	Quick Start manual
1	Wall holder (screwed to device)
1	Installation fittings (2 screws, 2 plugs for flush mounting)
1	Microfiber screen cleaning cloth

Front Layout

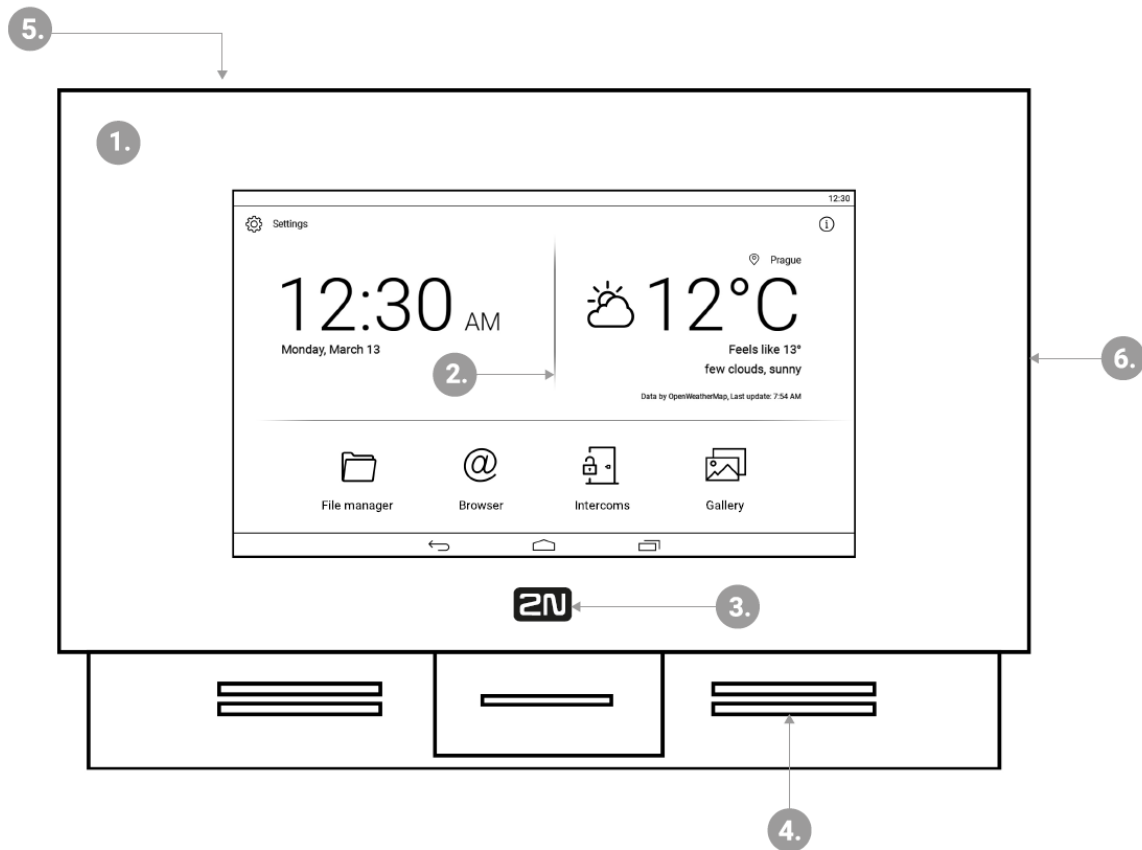

1. Glass frame
2. LCD display with capacitive touch layer
3. Status RGB LED
4. Loudspeaker
5. Microphone
6. Micro SD card slot

Backside Connectors

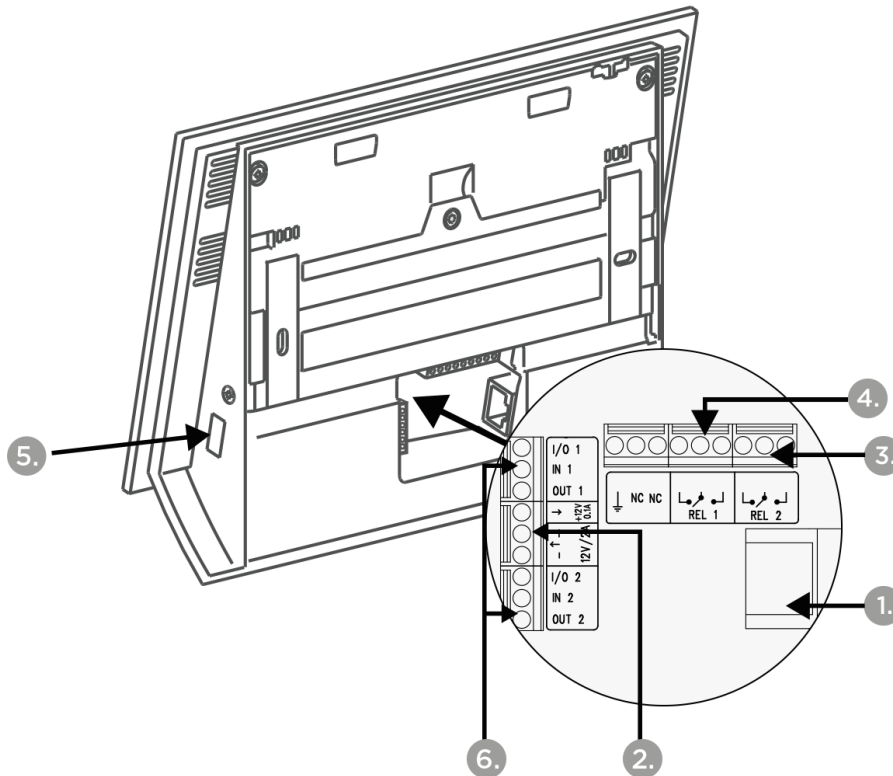

1. RJ-45 LAN 10/100BaseT connector
2. 12 V / 0,75 A DC supply terminal board (only if PoE is not used)
3. Restart/Factory reset button
4. Binary input/output terminal board (for application control)
5. Micro SD card slot
6. Logic inputs and outputs

✓ **Tip**

- External doorbell button or Relay connection guides are available at faq.2n.cz.

⚠ **Warning**

- Do not remove the backside rubber sealing as it improves the acoustic properties of the product during wall mounting.

2.2 Brief Installation Guide

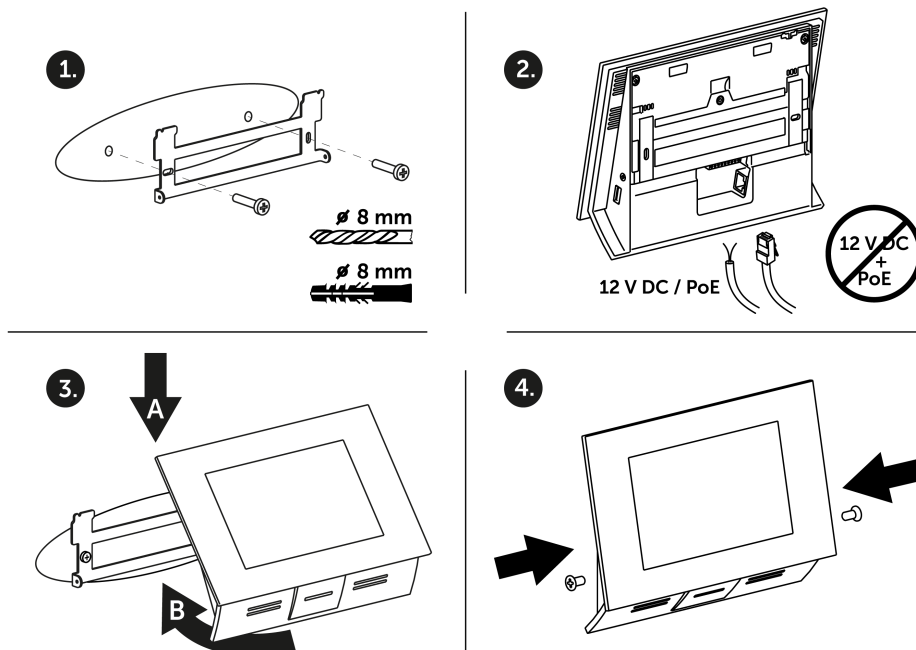

1. Install the device holder onto a vertical wall. The recommended installation height is 120 cm above the floor. The product package includes screws and plugs for mounting into classic bricks. Use appropriate installation fittings for a different type of wall material!
2. Feed the device via an Ethernet PoE adapter (or PoE supporting Ethernet switch/router) or a 12 V / 0,75 A DC power adapter.
 - a. With PoE supply, just snap RJ-45 into the appropriate connector.
 - b. With 12 V DC 0,75 A supply, screw the power adapter plus and minus cables into the appropriate terminal board on the device.
 - c. Simultaneous PoE + 12 V / 0,75 A DC supply is not recommended!
3. Put the device on the holder as follows:
 - a. Place the device carefully from top to bottom with its bottom part slightly away (up to 5 cm) from the wall.
 - b. When the device fits to the main holder supports, push the device bottom part onto the wall.
4. Tighten the safety screws on both the device sides.

⚠ Caution

- Before starting the mechanical installation on a selected place, make sure carefully that the preparations connected with it (drilling, wall cutting) cannot damage the electrical, gas, water and other existing wires and pipes.

2.3 Installation Conditions

Make sure that the following **2N® Indoor Touch 2.0** installation conditions are met:

- There must be enough space for device installation.
- Device is designed for vertical wall mounting (perpendicular to the floor) in the height of up to 120 cm above the floor. If necessary, operate device in a position other than as aforementioned for a short time only, for quick testing purposes in a servicing centre, for example.
- Exceeding the allowed operating temperature may not affect the device immediately but leads to premature ageing and lower reliability. Refer to [6. Technical Parameters](#) for the acceptable range of operating temperatures and relative humidity values.
- Device is not designed for environments with increased vibrations such as means of transport, machine rooms and so on.
- Device is not intended for dusty environments and places with unstable humidity and abrupt temperature changes.
- Device may not be exposed to aggressive gas, acid vapours, solvents, etc.
- Device is not intended for direct connection into the Ethernet/Internet.
- Device must be connected to the Ethernet/Internet via a separating active network element (switch/router).
- Device is designed for indoor use. It may not be exposed to rain, flowing water, condensing moisture, fog, etc.
- Device cannot be operated on places exposed to direct sunshine and near heat sources.
- Keep some free space above and below device to allow air to flow and conduct heat away.
- No strong electromagnetic radiance is allowed on the installation site.
- The VoIP connection must be configured properly according to the SIP and other VoIP recommendations.
- It is recommended that the power adapter be connected to the mains via a UPS and reliable overvoltage protection.

Wall Mounting

2N® Indoor Touch 2.0 is designed for wall mounting. Follow the steps below:

1. Unscrew the holder-fitting screws on the device sides.
2. Turn the metal holder slightly aside in the upper part of the device.
3. Move the holder downwards.
4. Fit the loose holder to the wall on the installation site.
5. Put the device on the holder and tighten the safety screws.

Follow the installation instructions printed on the device package.

Power Supply Connection

You can feed **2N® Indoor Touch 2.0** as follows:

1. Use 12 V / 0,75 A DC power adapter (order no. 91378381E/91378381GB/91378381US) connected to the terminal board.
2. Use an Ethernet cable connected to a PoE supply or PoE supporting Ethernet switch/router.

A successful operation is indicated by a status RGB LED or LCD display.

PoE Supply Connection

Use a standard straight RJ-45 terminated cable to connect device to the Ethernet. The device supports the 10BaseT and 100BaseT protocols. The Ethernet connection state is indicated by the LEDs placed on the RJ-45 connector.

Refer to [3.3 Device Configuration](#) for the factory settings of the device Ethernet interface.

Caution

- Factory reset results in a change of the Ethernet interface configuration!
- A defective Ethernet cable may lead to a high packet loss in the Ethernet and subsequent instability and poor video call quality!

Warning

- Connection of a defective or improper power adapter may lead to a temporary or permanent failure of the **2N® Indoor Touch 2.0** unit!

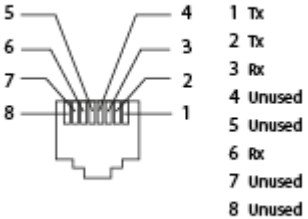
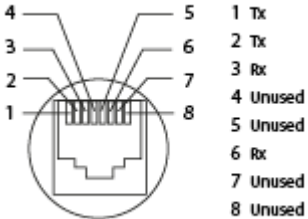
Ethernet cable connector	Ethernet port
 <p>5 4 1 Tx 6 3 2 Tx 7 2 3 Rx 8 1 4 Unused 5 Unused 6 Rx 7 Unused 8 Unused</p>	 <p>4 5 1 Tx 3 6 2 Tx 2 7 3 Rx 1 8 4 Unused 5 Unused 6 Rx 7 Unused 8 Unused</p>

Warning

- This product cannot be connected directly to the telecommunications lines (or public wireless LANs) of any telecommunication carriers (e.g. mobile communications carriers, fixed communications carriers, or internet providers). In the case of connecting this product to the Internet, be sure to connect it via a router.

Licence Limitations

2N® Indoor Touch 2.0 can contain time-limited software licences. Refer to [3.3 Device Configuration](#) for details.

Firmware Upgrade

We recommend you to upgrade the device firmware during installation. Refer to www.2n.cz for the latest FW version. Refer to [3.4. Device Upgrade](#) for the firmware upgrade procedure.

2.4 Status LED

Status LED indicates the device states when the LCD display is switched off or the device is in the service mode. See the table below for the LED colours and states:

Device Startup:

Colour	State
Blue is on	Device initialisation

Colour	State
Red is on	First boot phase
Green is on	Operating system start
Yellow is on	Factory setting initialisation
Blue is flashing	Factory reset
Purple is flashing	System upgrade process
No light	Device state is displayed

Standard Operation:

Colour	State
No light	Device state is displayed
Blue is on	Stand-by mode (display off)
Red flashing	Missed call notification on the device.
Other states	Notification of other states of applications running in the system (2N® IP Mobile , e.g.).

2.5 First Startup

When you start the device for the first time, the initial initialisation (longer start) is performed and indicated by the following LED notification sequence: **Red** → **Blue** → **Green** → Boot animation on the screen → Introductory system screen.

The introductory screen provides essential information for User Manual saving/reading. Select "Don't show welcome screen and run **2N® IP Mobile** at next start instead" to deactivate this screen for future system startups.

⚠ Caution

- If you do not select the "Don't show welcome screen and run **2N® IP Mobile** at next start instead" option on the welcome screen before quitting and then enable the **2N® IP Mobile** launch after the system startup in the Launcher configuration, the application will not be started for technical reasons. Therefore, be sure to disable the welcome screen start to make **2N® IP Mobile** run automatically after the system startup.

The table below shows the factory values of relevant device parameters:

Parameter	Value
IP address	will be assigned by the DHCP server
IP mask	will be assigned by the DHCP server
IP gateway	will be assigned by the DHCP server
Access password to configuration	2n
Administrator password	2n
Time/weather location	Prague, CZ
Stand-by switching time	1 minute
SW licence	Basic unlimited licence (or according to the Part No.)

⚠ Caution

- Change the access password while configuring the device for the first time to avoid unauthorised access to configuration!

System Licence

2N® Indoor Touch 2.0 has a factory licence key, which can be time-limited (depending on the Part No.). The licence expiry may cause a partial limitation of the device functionality! Refer to [3.3 Device Settings](#) for the current licence state and licence adding procedure if necessary.

3. 2N® Indoor Touch 2.0 Configuration

This section describes the **2N® Indoor Touch 2.0** configuration.

Here is what you can find in this section:

- [3.1 Factory Reset](#)
- [3.2 Home Screen](#)
- [3.3 Device Configuration](#)
- [3.4 Device Upgrade](#)

3.1 Factory Reset

Follow the steps below to reset the **2N® Indoor Touch 2.0** factory values:

1. Press the Factory Data Reset button in Settings / Administrator mode – ON / Backup & reset.
2. Remove the device from the installation holder:
 - a. Press and hold the Reset button on the device backside.
 - b. Press and hold the Reset button until the notification RGB LED lights up (yellow, approx. 10 seconds).
 - c. Release the Reset button and follow the instructions displayed.

Caution

- You can reset the factory values only if the administrator mode is on.
- Factory reset results in a complete deletion of all user data.

3.2 Home Screen

The Home Screen is divided into three subsections: Current time and date, Weather widget and five configurable application positions. The Setting and Information buttons are also available here.

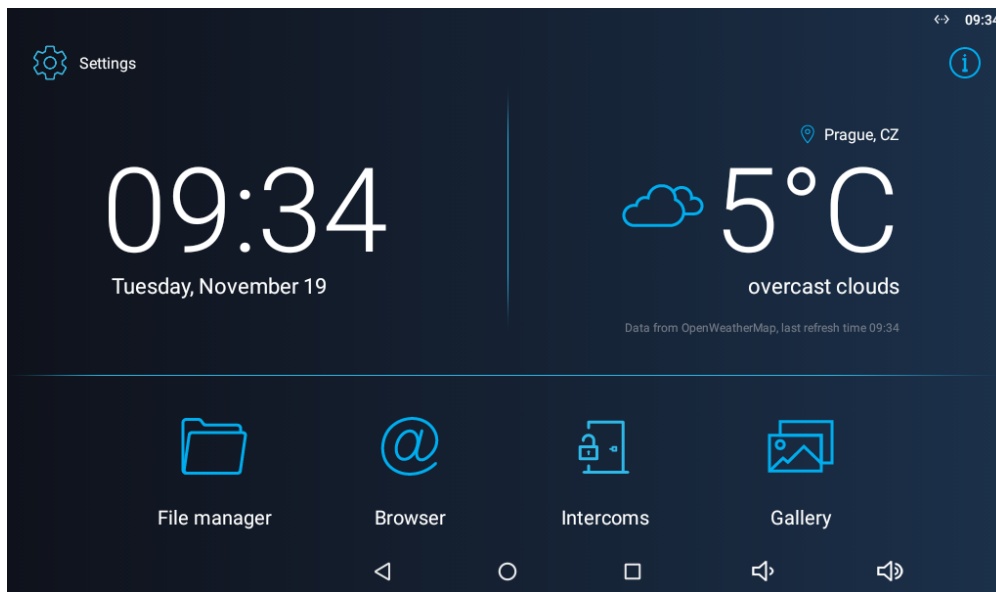

Factory settings:

- **Time/Date** tiles
- **Weather** tile
- **File Manager** – standard file system application
- **Browser** – Internet browser application
- **Intercoms** – application responsible for communication of the 2N IP intercoms with other answering units
- **Gallery** – photo/image processing application

The lower graphic bar includes five graphic controls:



- **Back icon (triangle)** – return one level higher or one step back (depending on the application type).
- **Home icon (circle)** – return to the introductory screen.
- **Square icon** – switch the currently launched applications.
- **Speaker icons** – increase/decrease the system loudspeaker volume.

Notification Bar

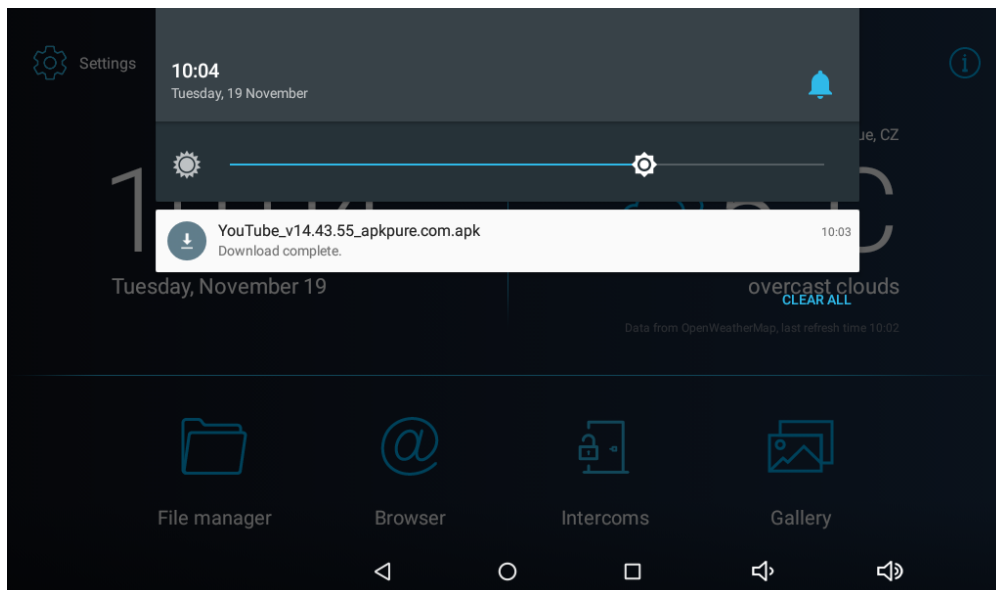

The notification bar provides a list of missed events and notifications allowing you to set the DND mode and display brightness level instantly. Swipe your finger in a straight downward line from the upper edge of the screen to pull down the notification bar. Click the Delete all icon to remove the notification list.

3.3 Device Configuration

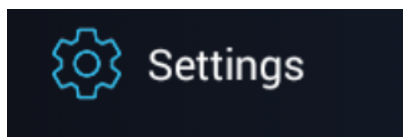

Click the **Settings** button on the introductory page to access the configuration section. Complete the correct access password.

 **Caution**

- The factory access password is "2n". If you lose the access data, you will have to factory reset the device! Change the password in the Settings / Personal / Language & input.

- **Administrator mode** – configure advanced functions.

The device configuration consists of five sections: Device, Wireless & Networks, 2N® IP Mobile, Personal, System; each section is divided into subsections, see below.

- [User Settings](#)
- [Administrator Settings](#)

 **Warning**

- You are not recommended to disconnect the device from the power supply within 30 s following the last setting change to avoid loss of the settings.

3.3.1 User Settings

This subsection describes the settings that can be accessed without the administrator password. The subsection contains the following parts:

- [3.3.1.1 Device](#)
- [3.3.1.2 Personal](#)
- [3.3.1.3 System](#)

3.3.1.1 Device

This section helps you set the first menu level and quick navigation parameters (click any subsection) into selected device configuration sections.

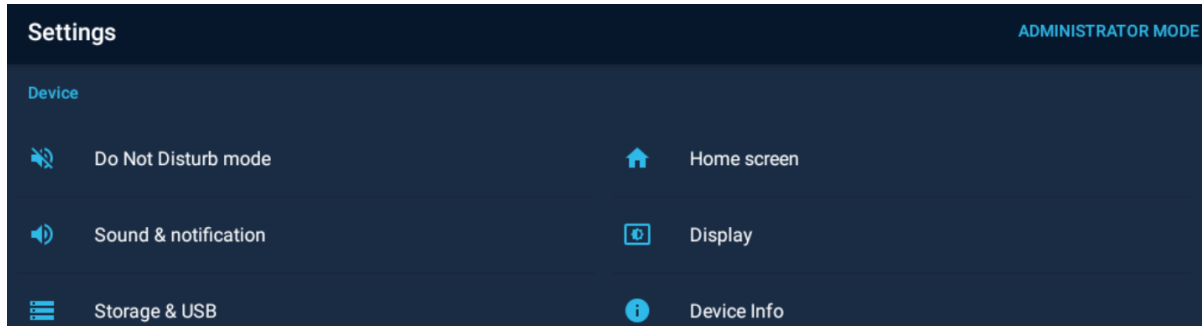

Do Not Disturb Mode

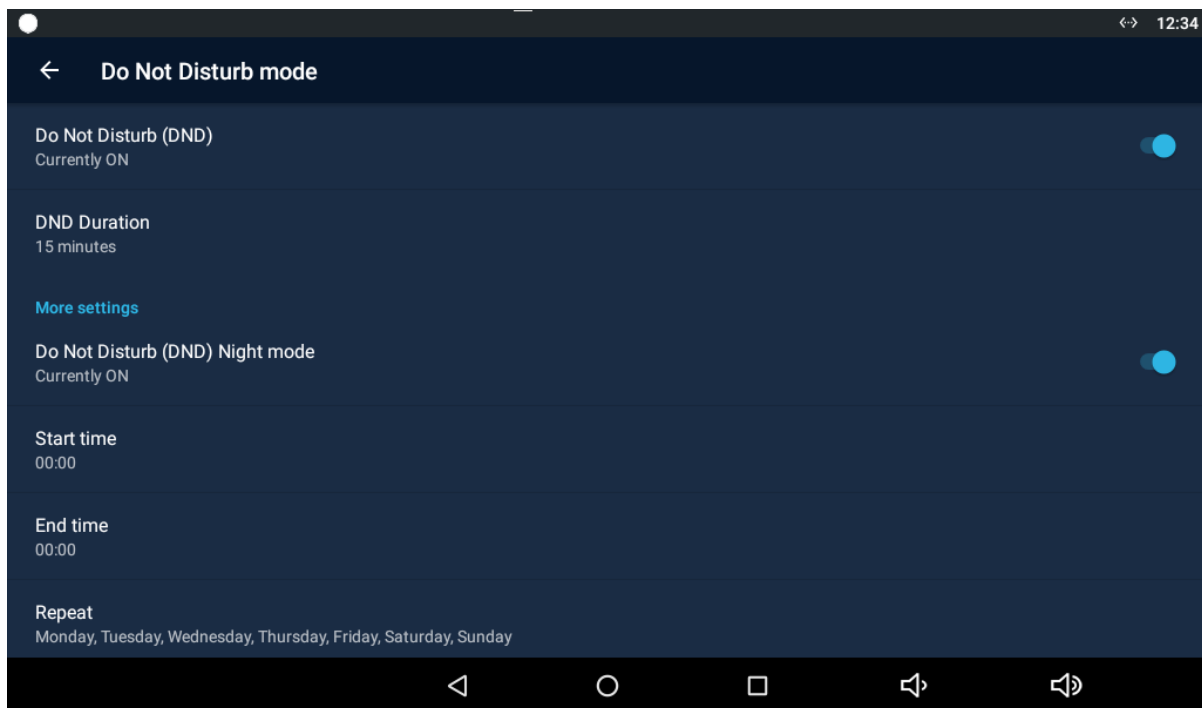

- **Do Not Disturb (DND)** – disable any notification while DND is active. While activating DND you can set any interval in the range between 15 minutes and 24 hours, or permanently.
- **Do Not Disturb (DND) Night mode** – disable any notification while DND is active. Set this mode for each weekday with repetition and specify the start and end time.

- **Start time** – set the beginning of the DND Night mode time validity.
- **End time** – set the end of the DND Night mode time validity.
- **Repeat** – set the days on which the DND Night mode is to be applied repeatedly.

Home Screen

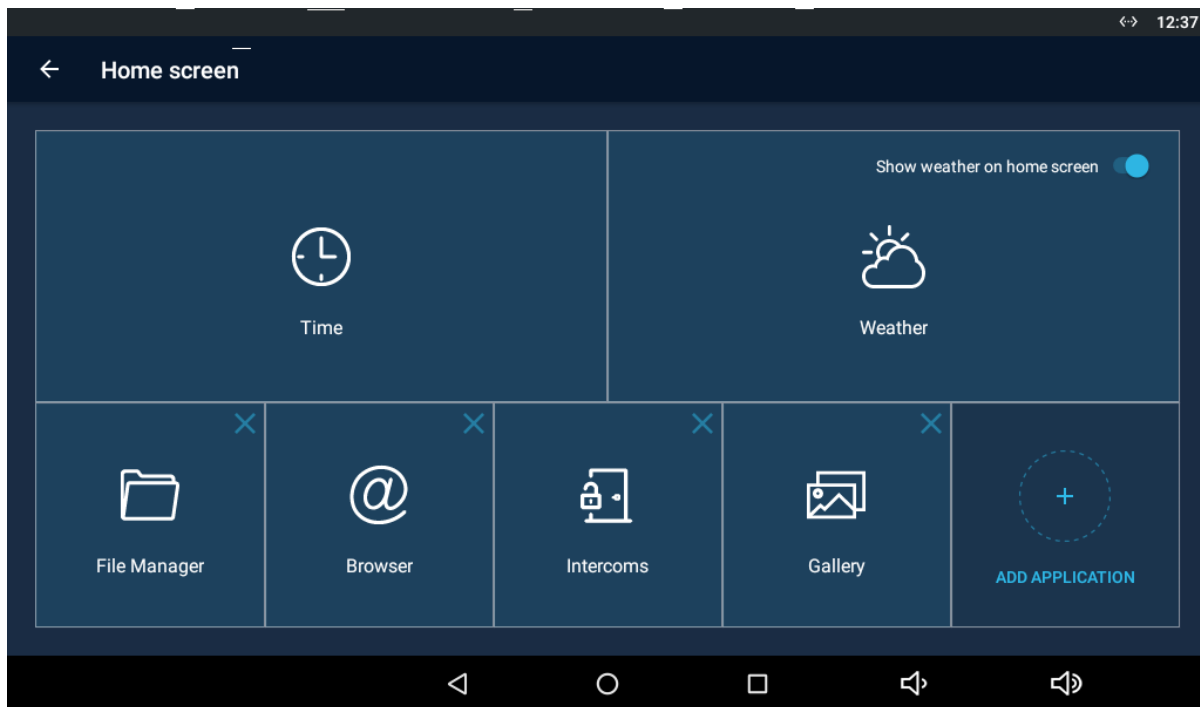

- **Time** – click to move the user to the section for setting the time, time format and time zone.
 - **Automatic date & time** – activate the use of date and time from the network.
 - **Set date and time** – set the date and time manually if Automatic date and time is disabled.
 - **Select time zone** – set the time zone for the installation site to include the time shift and summer/winter time transition.
 - **Use 24-hour format** – display the 24-hour format. If disabled, the 12-hour format is displayed including the a.m./p.m. information.
 - **Choose date format** – select one of the three available date formats.
- **Weather** – click to move the user to the section for setting the current weather forecast. Use the introductory weather tile to deactivate the function. Deactivate the weather tile if necessary.
 - **Position** – set the geographical position of the installation site manually.
 - **Refresh frequency** – set 60 or 120 minutes for weather info refreshment.
 - **Units** – set metric (°C) or imperial (°F) units.

- **Source** – display the weather info source.



- The weather forecast location includes the town and abbreviated country name. If typed incorrectly, the weather forecast will not be displayed. make sure that the Internet is connected while setting the location. refer to <http://openweathermap.org/> for location codes.

Pre-Installed Applications

- **File Manager** – a file management application, which can be replaced with any other application.
- **Browser** – a www navigation tool, which can be replaced with any other application.
- **Intercoms** – provides communication with the 2N IP intercoms and other answering units and can be replaced with any other application.
- **Gallery** – an image/photo processing application, which can be replaced with any other application
- **Add Application** – add an application from a list and edit its name/icon if necessary.

Note

List of preinstalled applications:

- | | |
|--------------------------|----------------|
| • AXIS Companion Classic | • E-mail |
| • AXIS Camera Station | • Calendar |
| • Music | • Calculator |
| • File Manager | • Adobe Reader |
| • Clock | • Browser |
| • Galery | • Intercoms |

Caution

- The application installations depend on the product licensing. Make sure that the **APP** key is active to install an application. Check Settings / Device / Licence after activating the administrator mode for the current licence state.

Sound & Notification

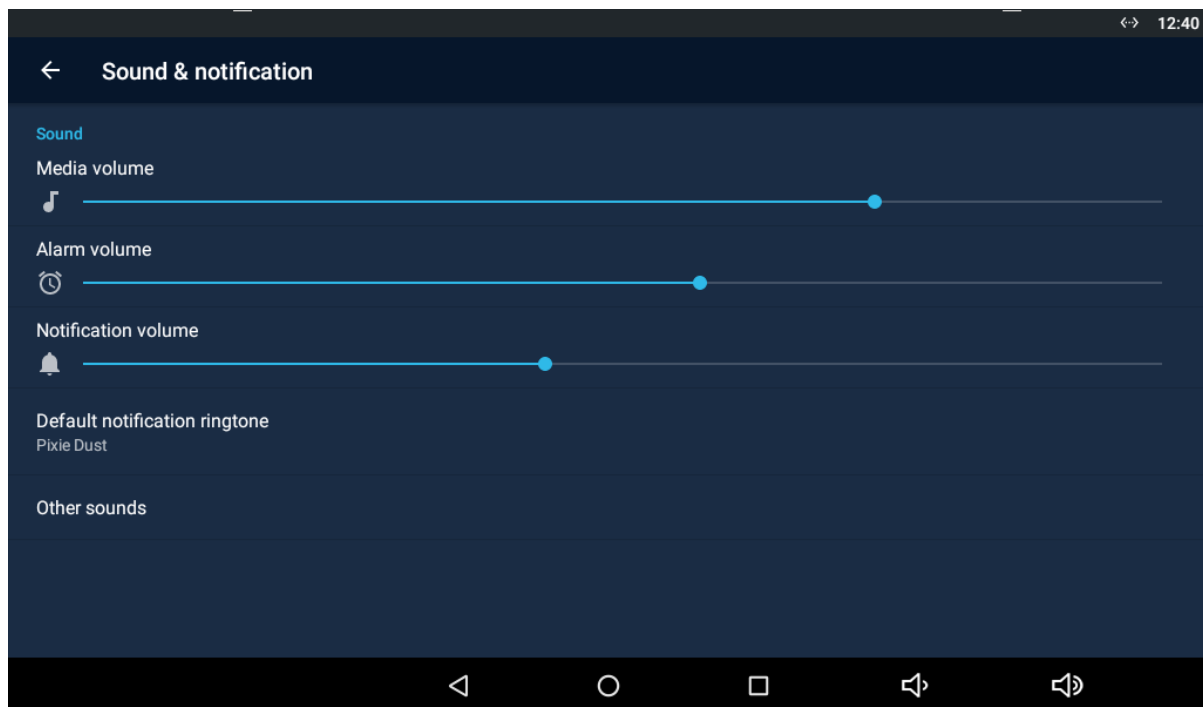

- **Media volume** – set the media volume.
- **Alarm volume** – set the alarm clock volume.
- **Notification volume** – set the default notification ringtone volume.
- **Default notification ringtone** – set the default notification ringtone.
- **Other sounds** – enable/disable sound signalling.
 - **Touch sounds** – enable/disable the display touch sound.

✓ Tip

- Set the ringtone in [3.3.3.2 Call Settings](#).

Display

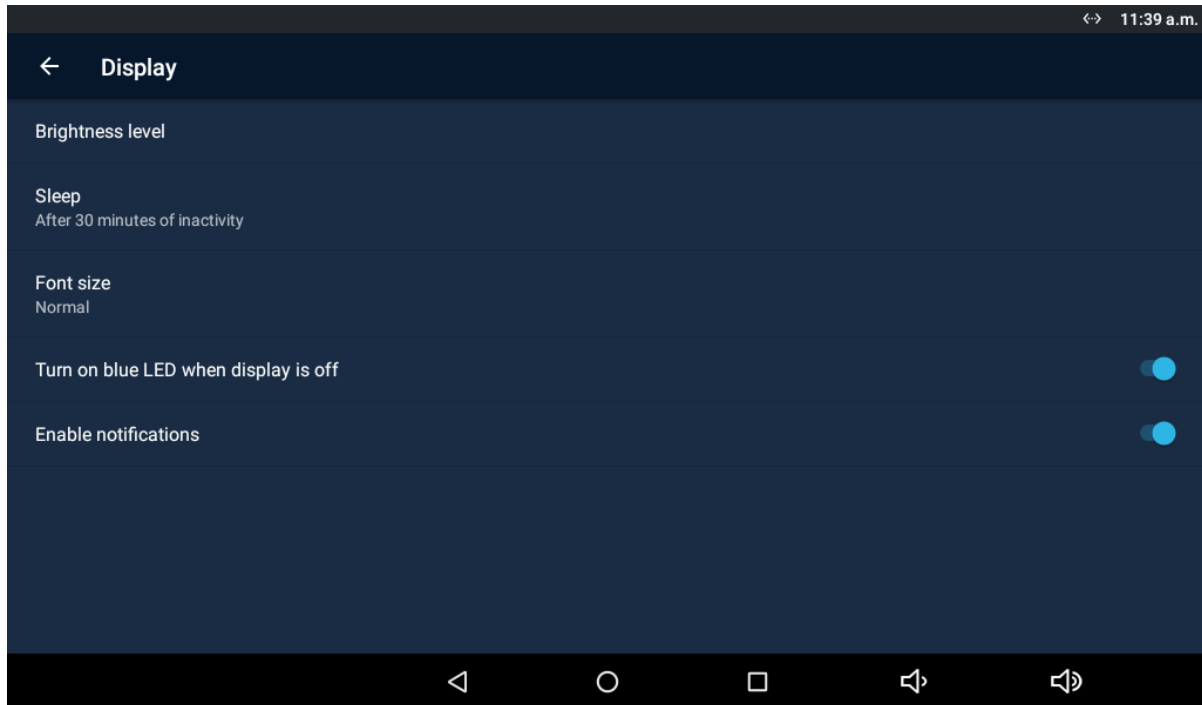

- **Brightness level** – set the backlight brightness values.
- **Sleep** – set the maximum user idle timeout after which the sleep mode is automatically switched on. Select a value between 15 seconds and 30 minutes.
- **Font size** – set the font size: Small / Normal / Large / Very large.
- **Turn on blue LED when display is off** – turn the blue LED on when the display is off.
- **Enable notifications** – enable missed call notifications on the device. The status LED flashes red to indicate a missed call.

Storage & USB

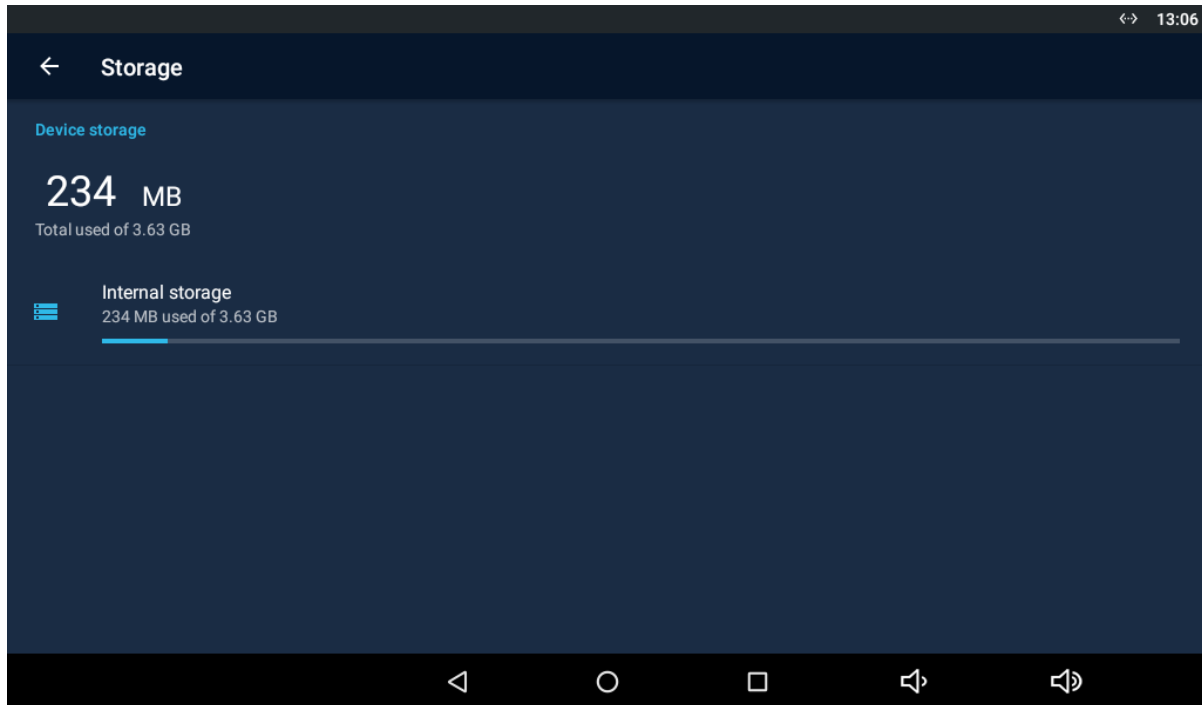

- **Internal storage** – display the internal storage state for downloaded files and photos. Click to display the storage details.

Advanced

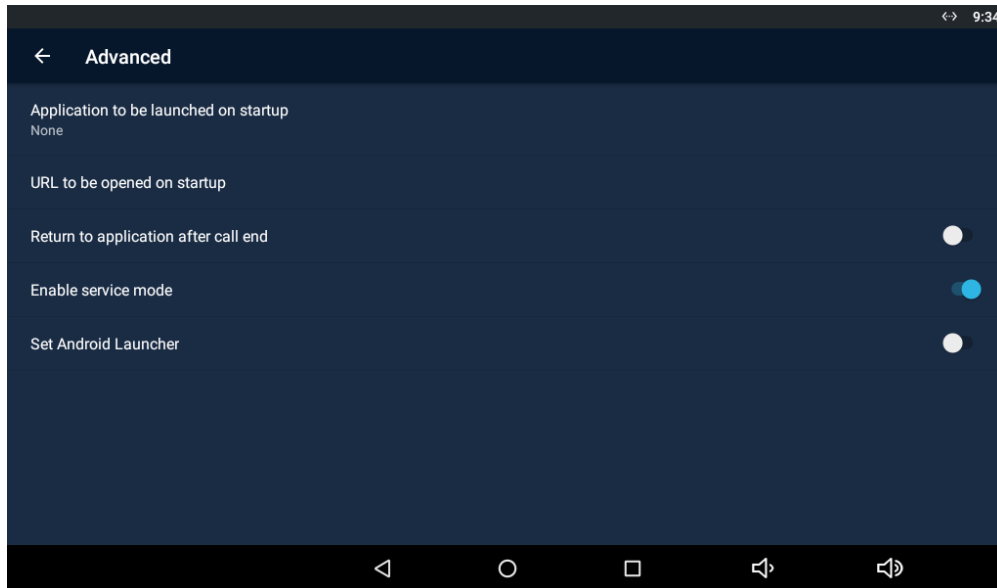

The Advanced subsection is only available when the administrator mode is active.

- **Application to be launched on startup** – display the list of available applications. Select the application to be launched upon startup.
- **URL to be opened on startup** – set the URL address to be opened upon startup.
- **Return to application after call end** – set return to the application when the call is terminated.
- **Enable service mode** – allow the device to be connected via a service tool.
- **Set Android Launcher** – set the Android Launcher.

Licence

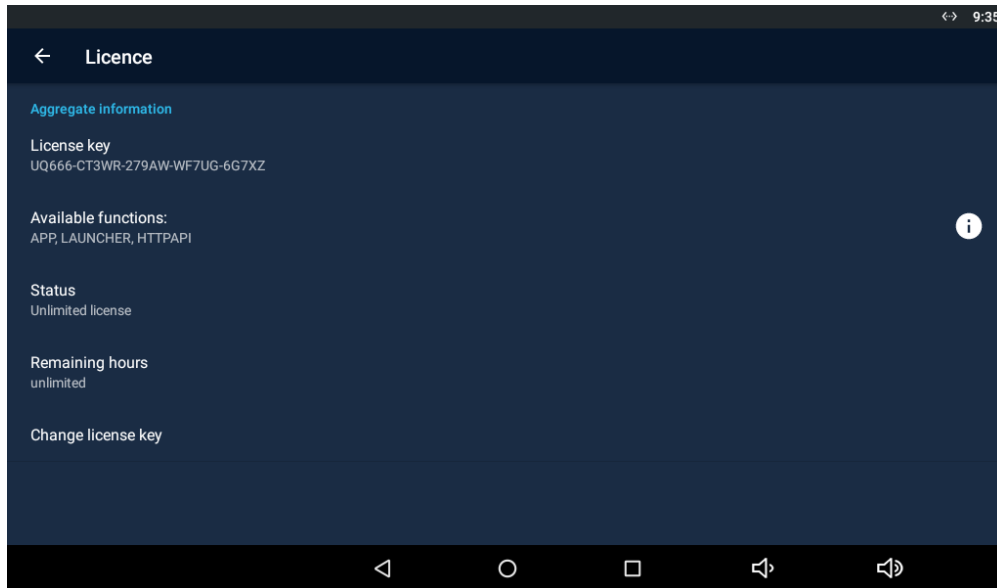

The Licence subsection is only available when the administrator mode is active.

- **Licence key** – display the licence key used.
- **Available functions** – display the list of available functions depending on the licence type purchased.
- **Status** – display the licence type (limited, unlimited).
- **Remaining hours** – display the licence remaining hours.
- **Change licence key** – change the licence key.

Caution

- The original licence key will be overwritten by the new one! Be sure to insert a valid licence key obtained from your supplier!

Warning

- The **APP** licence unlocks **2N® Indoor Touch 2.0** for loading user applications from a microSD card (SDHC), up to 16 GB. If, however, any user applications are installed, **2N TELEKOMUNIKACE a.s.** does not guarantee a proper function and stability of such user applications and/or a correct function of the applications pre-installed in **2N® Indoor Touch 2.0**. Should troubles occur, remove the user applications or reset the **device** factory values to get rid of the user applications and settings.

Device Info

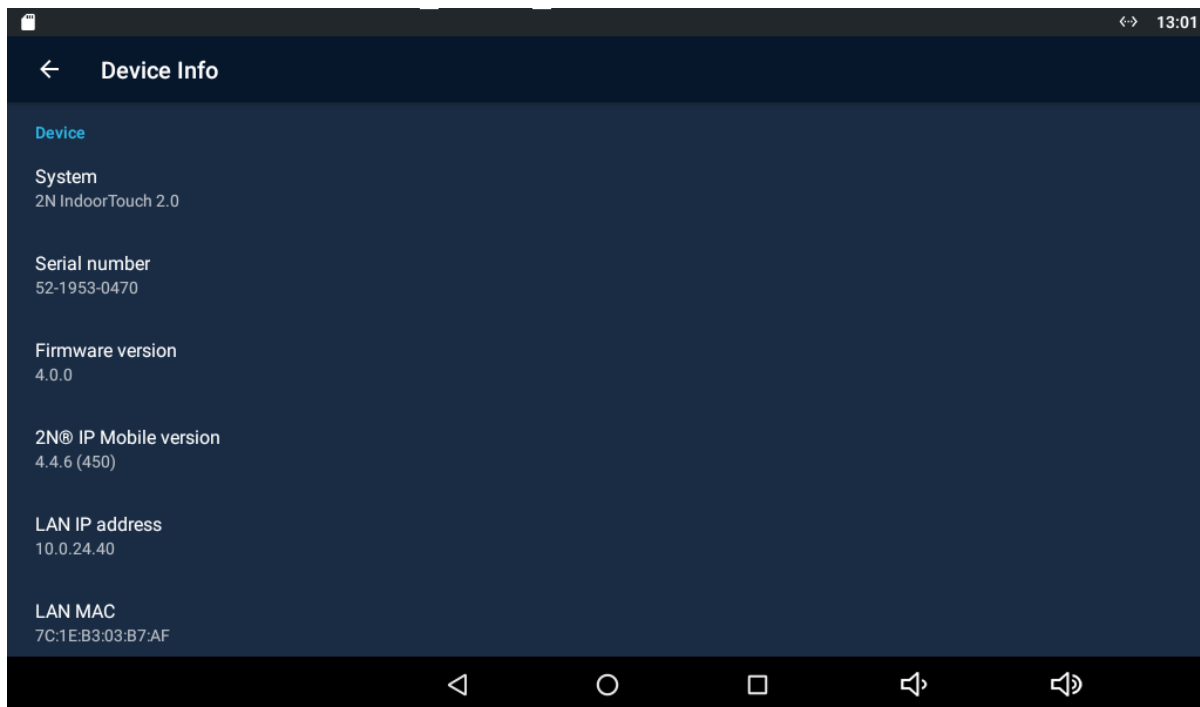

- **Device** – display basic information on the device (serial number, hardware version, firmware version...).
- **System** – display the official name of the device.
- **Date and time** – display the device date and time.
- **RAM info** – display the RAM state.
- **Legal information** – display the list of open-source licences used in the device.

3.3.1.2 Personal

The Personal section helps you set the device security and language parameters.



- [3.3.1.2.1 Security](#)
- [3.3.1.2.2 Language and Input Methods](#)

3.3.1.2.1 Security

Set the device security parameters.

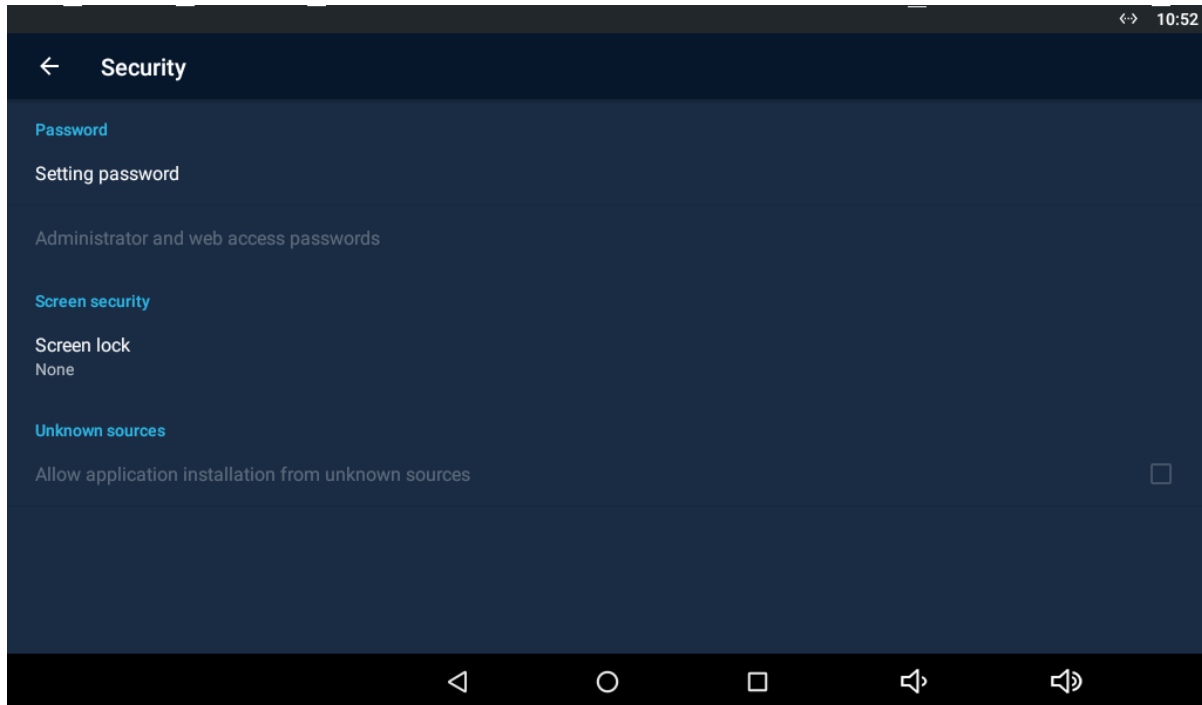

PASSWORD

- **Settings password** – set the setting access password.
- **Administrator and web access password** – set the administrator access password.

SCREEN SECURITY

- **Screen lock** – select the screen lock type: PIN, Character or None.

UNKNOWN SOURCES

- **Allow installation of apps from unknown sources** – allow installation of applications from unknown sources.

3.3.1.2.2 Language and Input Methods

Set the language parameters and text input methods.

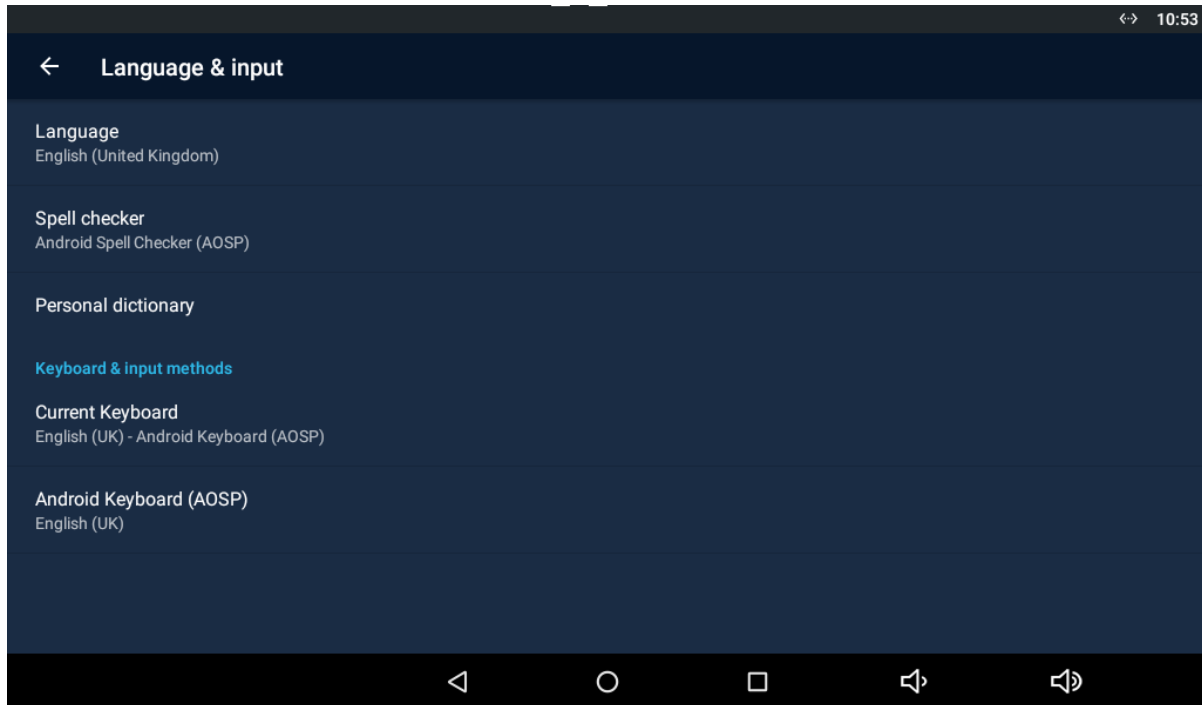

- **Language** – set the system language.
 - **Spell checker** – enable/disable the spell checker for the defined language.
- **Personal dictionary** – click Add (+) to add a word to your personal dictionary.

KEYPAD & INPUT METHODS

- **Current Keyboard** – set the keyboard type.
- **Android Keyboard (AOSP)** – set the keyboard parameters.

3.3.1.3 System

This section helps you set the system parameters.

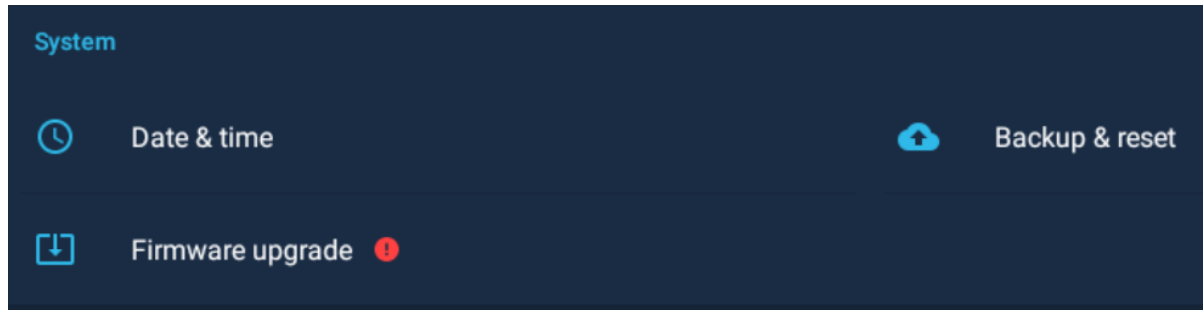

- [3.3.1.3.1 Date & Time](#)
- [3.3.1.3.2 Restart and Factory Reset](#)
- [3.3.1.3.3 Firmware Upgrade](#)

3.3.1.3.1 Date & Time

This section helps you set the device date and time parameters. Set the time, time format and time zone.

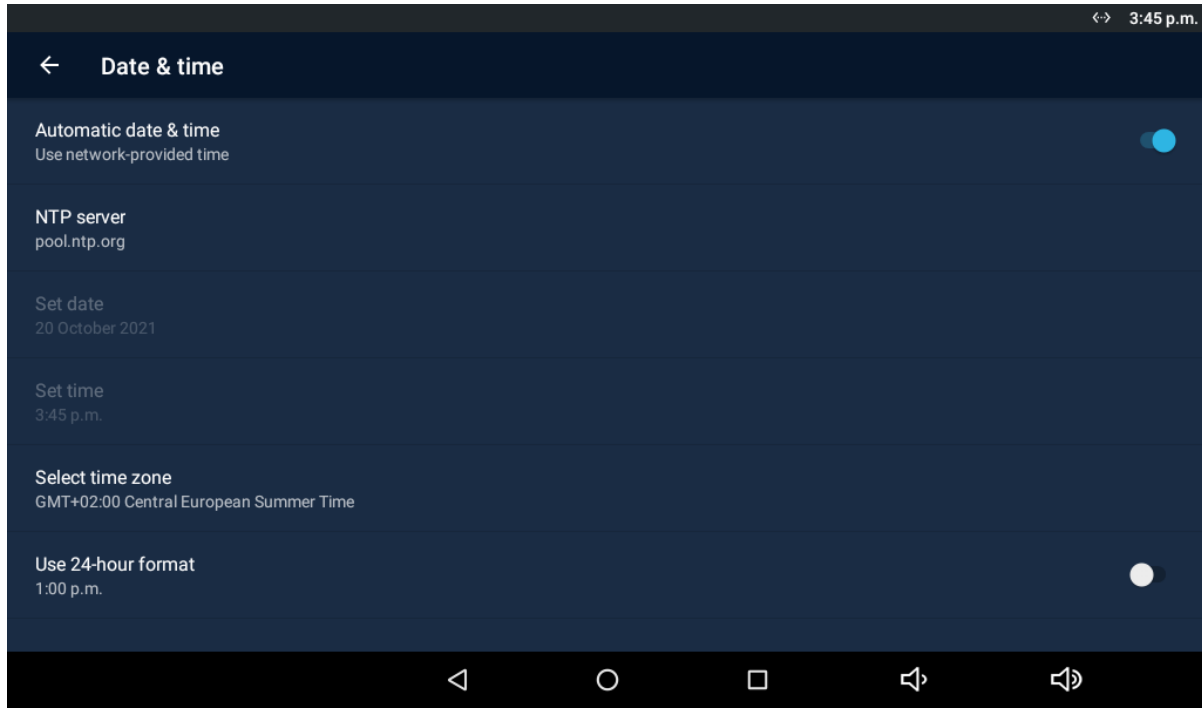

- **Automatic date & time** – activate the use of date and time from the network.
- **NTP server** – use the NTP server to synchronize the device time. Choose one of the default NTP servers (default pool.ntp.org, asia.pool.ntp.org, europe.pool.ntp.org, nort-america.pool.ntp.org, oceania.pool.ntp.org) or add another one manually.
- **Set date** – set the date manually if Automatic date & time date is disabled.
- **Set time** – set the time manually if Automatic date & time time is disabled.
- **Select time zone** – set the time zone for the installation site to include the time shift and summer/winter time transition.
- **Use 24-hour format** – display the 24-hour format. If disabled, the 12-hour format is displayed including the a.m./p.m. information.

3.3.1.3.2 Restart and Factory Reset

This section helps you set the device restart and factory data reset parameters.

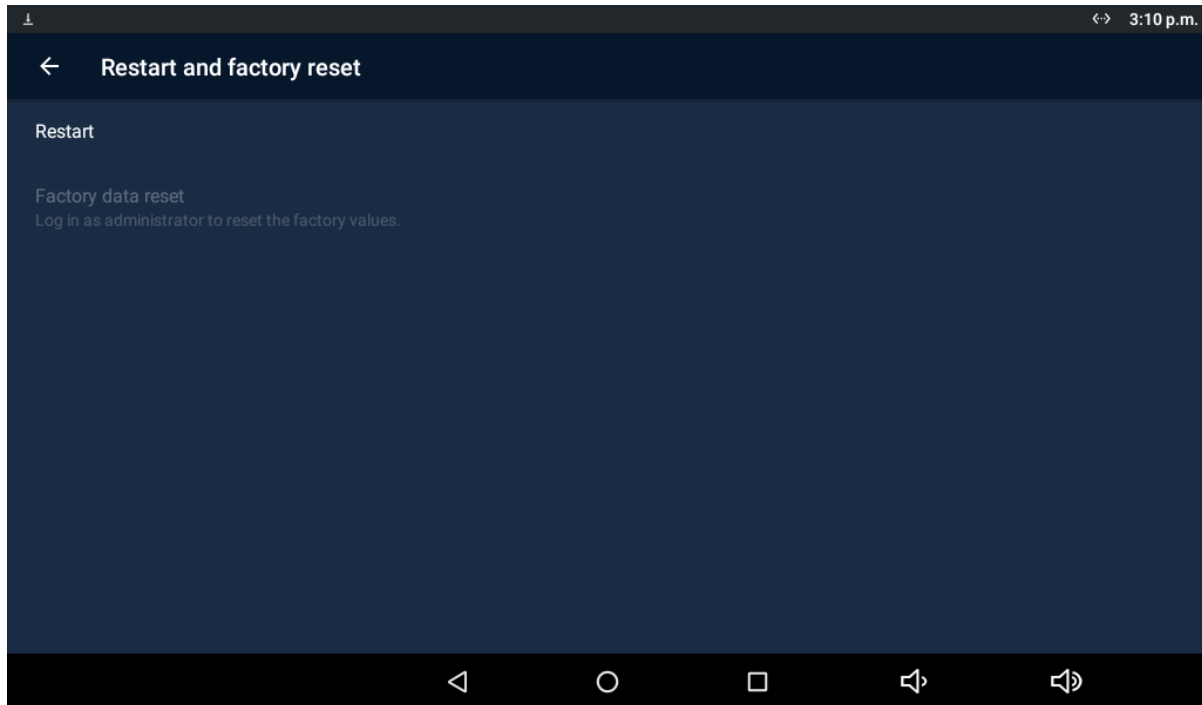

- **Restart** – restart the device.
- **Factory data reset** – delete all data from the internal storage including: system and application settings and data, downloaded applications, music, photographs and other user data. The factory data reset is only available in the administrator mode.

3.3.1.3.3 Firmware Upgrade

This section helps you maintain the current device firmware.

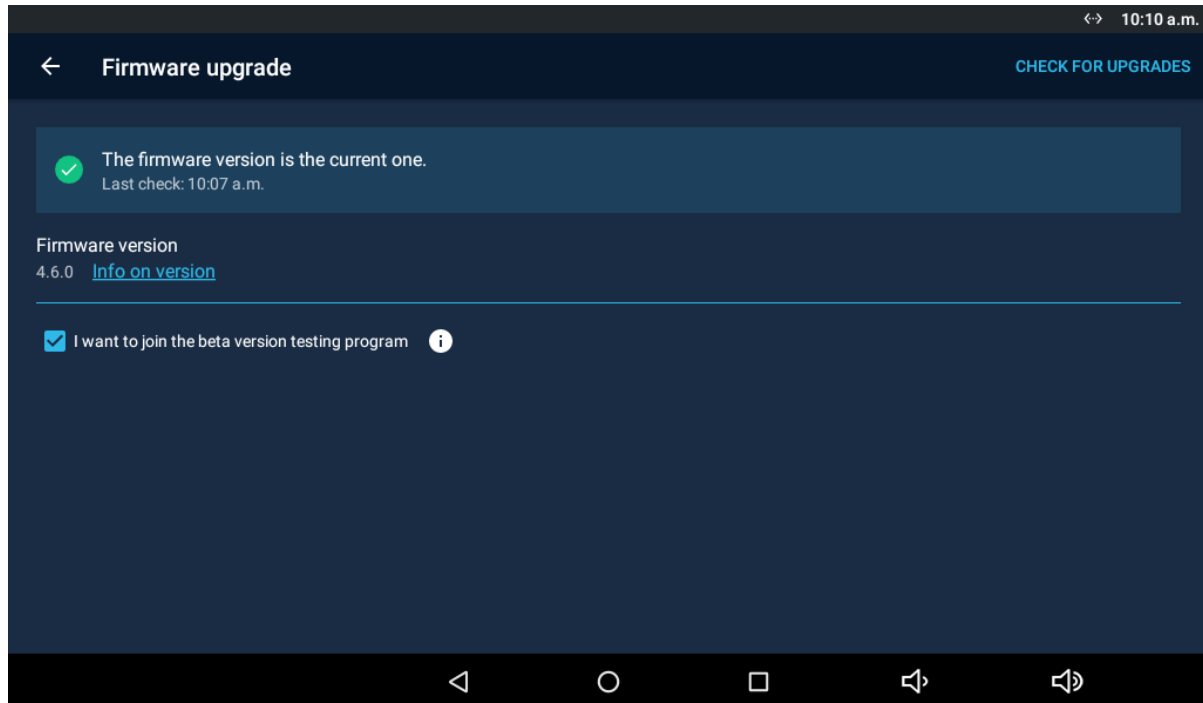

- **Check for updates** – check whether a new firmware version is available.
 - **Upgrade** – upload a new firmware version to the device.
- **Firmware version** – display the firmware version number installed in the device.
 - **Info on version** – display all the functions, enhancements and corrections of the version installed.
- **I want to join the beta version testing program** – new **2N® Indoor Touch 2.0** firmware versions are offered within the beta testing program before the public release.

⚠ Caution

- Downgrade to a version lower than 4.3.1 is not supported. The system notifies the administrator of any attempt to downgrade to a version other than the specified one.

3.3.2 Administrator Settings

On your first attempt to log into the administrator mode for advanced configuration, you are asked to enter the administrator password. The factory default password is 2n.

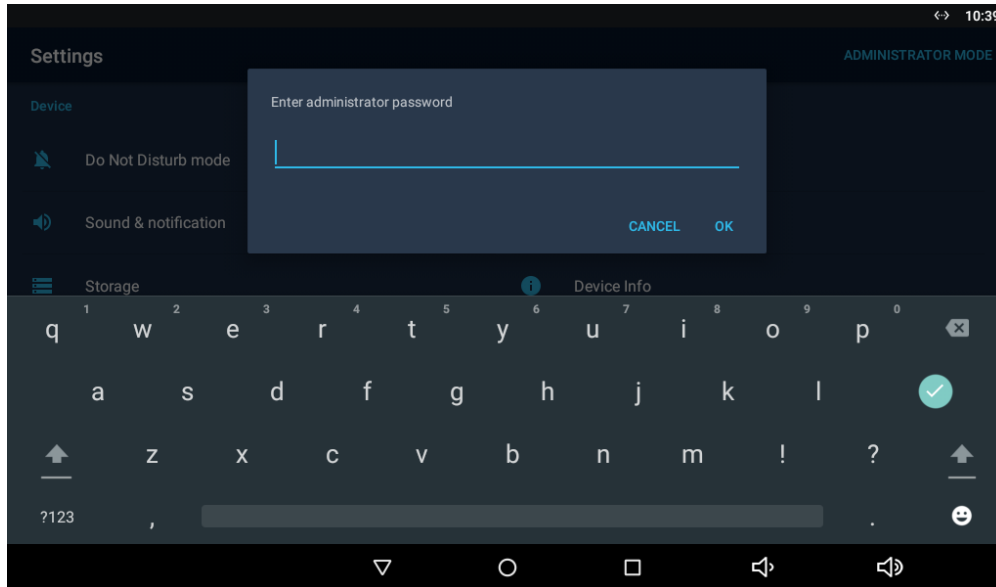

Having entered the default password, you are asked to change the password for security reasons. The password has to consist of a minimum of eight characters including one capital letter, one small letter and one digit at least.

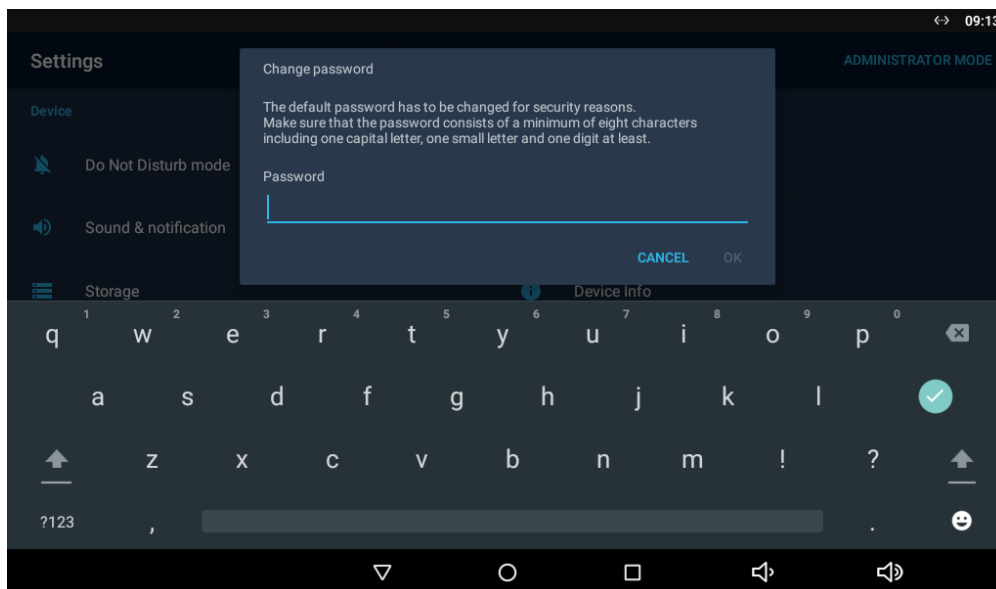

Retype the new password for confirmation.

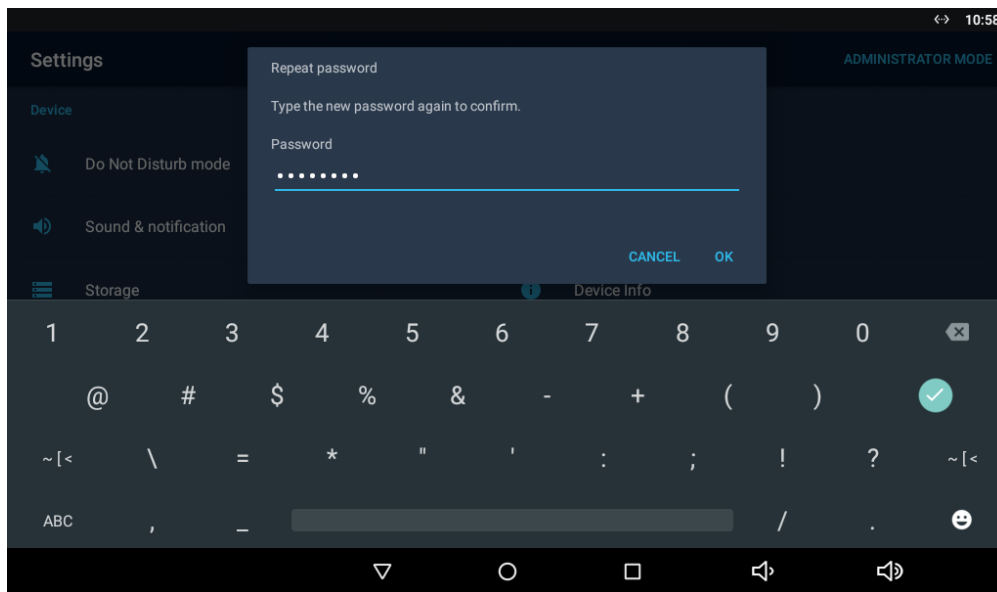

The Administrator Settings subsection describes the settings that can be accessed after the administrator password is entered. The subsection has the following parts:

- [3.3.2.1 Device](#)
- [3.3.2.2 Wireless & Networks](#)
- [3.3.2.3 Security](#)
- [3.3.2.4 Language & input](#)

3.3.2.1 Device

Advanced

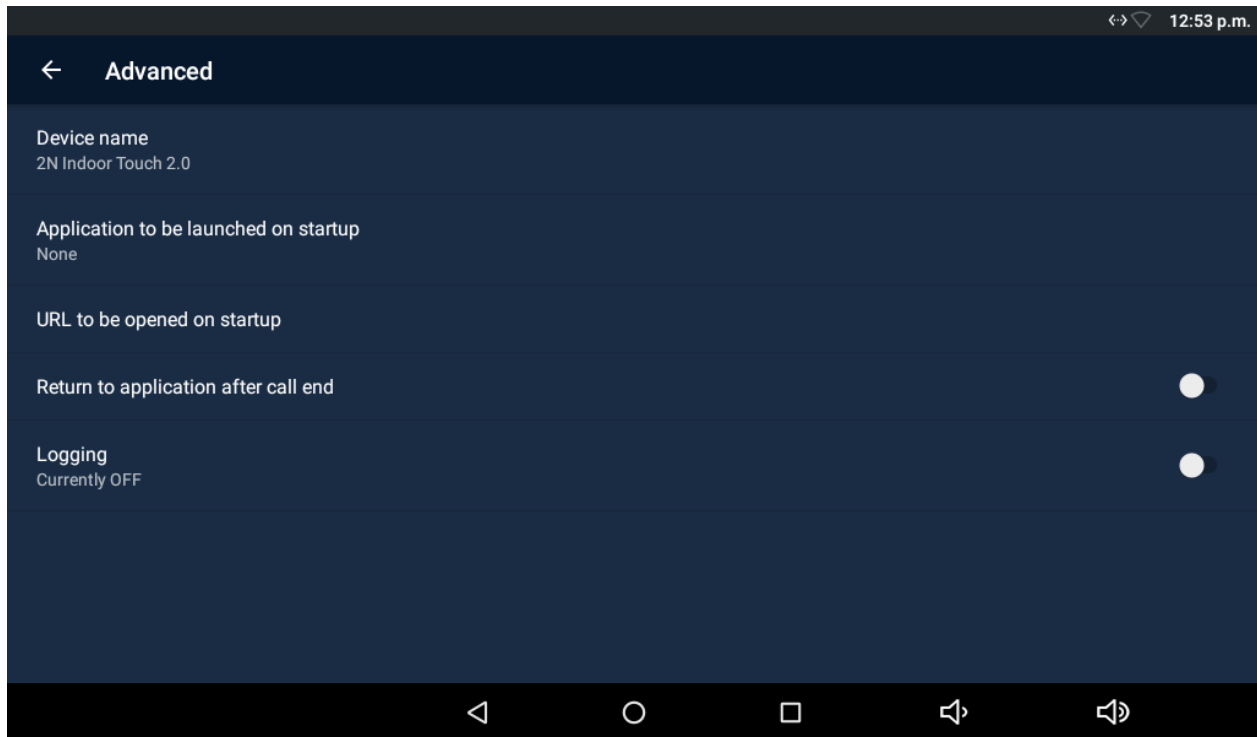

The Advanced subsection is available in the administrator mode only.

- **Device name** – user device ID. Shown in 2N® Network Scanner and 2N® IP Eye in the lists of LAN devices visible to other 2N devices.
- **Application to be launched on startup** – display the list of available applications. Select an application to be launched on startup.
- **URL to be launched on startup** – set the URL to be launched on startup.
- **Return to application after call end** – return to the application after the call is ended.
- **Logging** – enable/disable application logging to the system log.

⚠ Caution

- The application and URL are mutually exclusive upon startup.

Licence

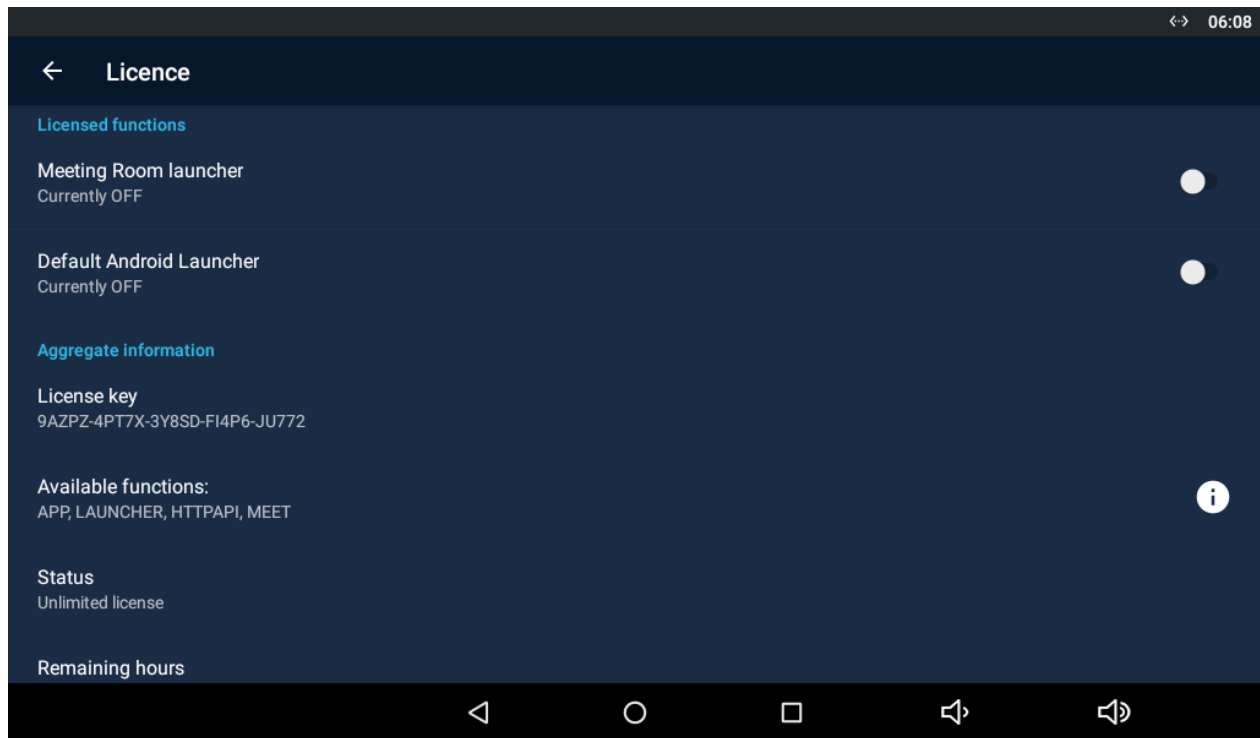

The Licence subsection is available in the administrator mode only.

Licensed functions

- **Meeting Room Launcher** – switch the home page to the **2N® Meeting Room** launcher.
- **Default Android Launcher** – set the home page to the default Android Launcher.

 **Note**

- Once the Meeting Room launcher is set, the **2N® Indoor Touch 2.0** call functions will be deactivated and the application will replace the home screen. All the notifications will be turned down and can be turned on additionally. Once the Meeting Room launcher is turned off, the default audio values will be restored.
- No custom application or URL are launched upon restart while the Meeting Room application is switched on.
- The Meeting Room launcher and Default Android launcher licensed functions are displayed only if the valid licence key is entered.

Aggregate information

- **Licence key** – display the licence key used.
- **Available functions** – display the list of available functions depending on the licence type purchased.
- **Status** – display the licence status (limited, unlimited).
- **Remaining hours** – display the hours remaining before the licence expires.
- **Change licence key** – change the licensed key.

 **Caution**

- The original licence key will be overwritten with a new one! Enter only the valid licence key obtained from your supplier!

 **Warning**

- The **APP** licence unlocks **2N® Indoor Touch 2.0** for uploading custom applications from a max 16 GB microSD card (SDHC). **2N TELEKOMUNIKACE a.s.** cannot guarantee functionality and stability of custom applications or proper function of applications pre-installed in **2N® Indoor Touch 2.0** once custom applications are installed. In case of troubles, remove the custom applications or reset the factory values. The factory reset shall restore the device's original state without custom applications and settings.

3.3.2.1.1 2N® Meeting Room App

The **2N® Meeting Room** application provides an easy management of meeting rooms. It shows the current and forthcoming events and helps you create a new meeting room reservation directly, thus making the meeting room reservation process more flexible and user friendly.



To activate the **2N® Meeting Room** function, add the licence key via the device web interface or directly to the device after logging into the Administrator mode, Device / Licence section.

The basic features of the **2N® Meeting Room** application include showing events including details and making reservations for selected meetings as well as support of and synchronisation with selected calendars. Support for the display of weather forecast, time and custom logo widgets is also provided.

2N® Meeting Room supports two modes. The outside (default) mode means that the device with the application is installed in front of the meeting room to show the ongoing and forthcoming events. For the inside mode, the device is installed inside the meeting room to show the remaining time of the current event.

Note

- Application function requirements:
 - **2N® Indoor Touch** with FW 4.3 version and higher
 - **2N® Meeting Room app licence** (Part No. **91378396**)

Settings – Connection

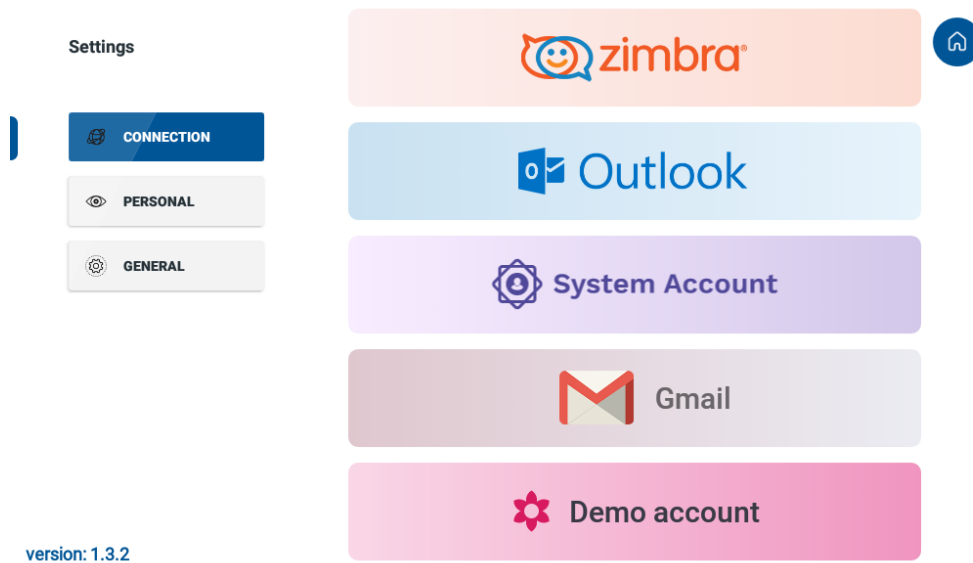

To display a calendar, the application supports synchronisation with the following shared post/calendar platforms:

- Microsoft Office 365 (Outlook)
- Microsoft Exchange (via Android system account)
- Gmail (Google Mail/Calendar)
- Zimbra

Tip

- Refer to the [FAQ](#) for how to synchronise the selected calendars with the **2N® Meeting Room** application.

Settings – Personal

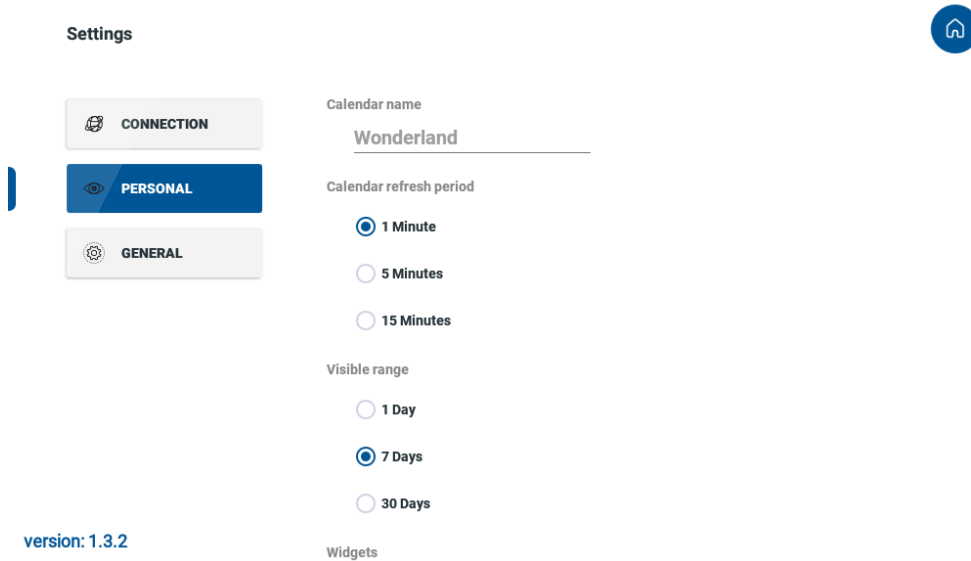

- **Calendar name** – set the calendar name for the selected meeting room.
- **Calendar refresh period** – set the calendar refreshing period.
- **Visible range** – set the visible time range of the calendar events.

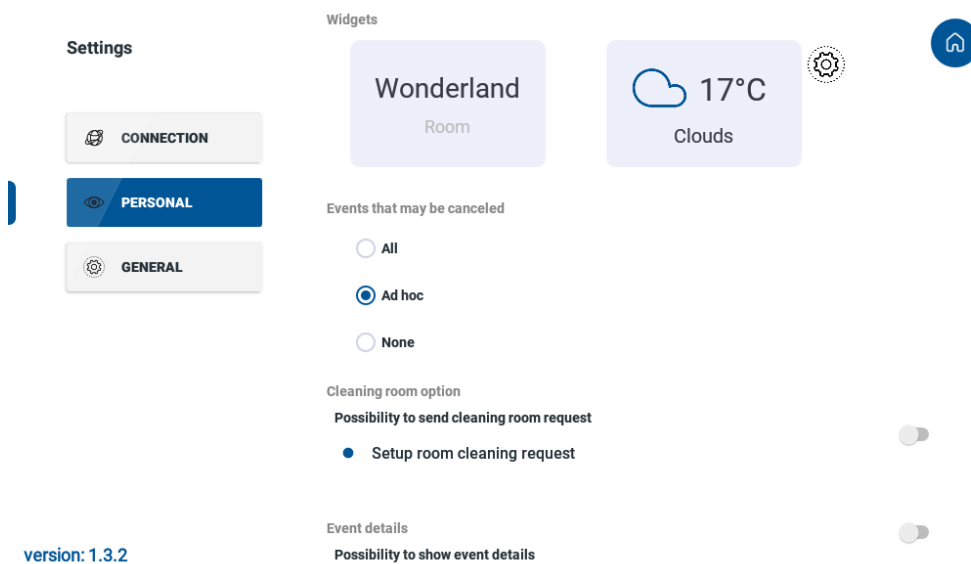

- **Widgets** – use the widgets to display selected information. Press the icon and choose up to 2 widgets (time and date, day in a week, meeting room name, logo) or no widget.
- **Events that may be canceled** – set the event cancelling rules for the application.
 - **All** – any user may cancel all events (all events mean the events created in a shared calendar or by the Ad hoc events created by the application in the device).

- **Ad hoc** – events created by the application may only be cancelled.
- **None** – no events may be cancelled.

✓ **Tip**

- The Ad hoc reservation is only possible if the meeting room is currently free for up to 60 minutes.

- **Cleaning room option** – send a meeting room cleaning request by fulfilling the recipient and a message for the recipient. Once it is saved, the function icon is displayed on the device in the application. Press the icon to send the request to the defined address.
- **Event detail** – display details on the selected event in the event list.
- **Logo** – upload and display a selected image/logo by fulfilling the valid image URL address. The supported formats are .jpg/.jpeg, .png, .bmp and .gif (just static display is supported without animation).
- **Inside room mode** – activate the application's inside mode for a device installed inside the meeting room to show the remaining time of the current event reserved.
- **Automatic confirmation** – set automatic event confirmation as every event requires user confirmation by default.

Settings – General

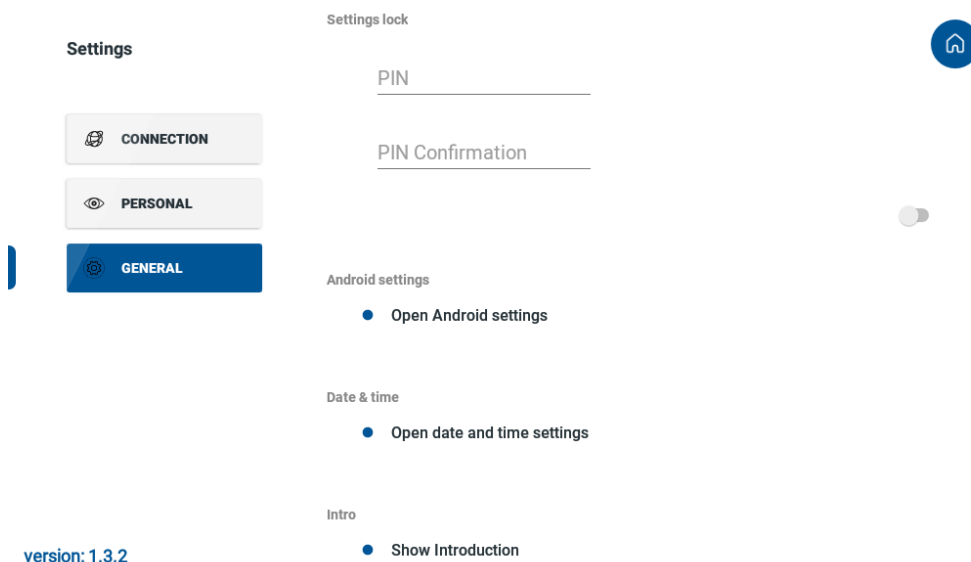

- **Settings lock** – set a PIN code to prevent unauthorised persons from making changes in the application.
- **Android settings** – open the Android settings of the device.
- **Date & time** – switch to the Date and time section in the Android settings.

- **Intro** – display a brief application survey.

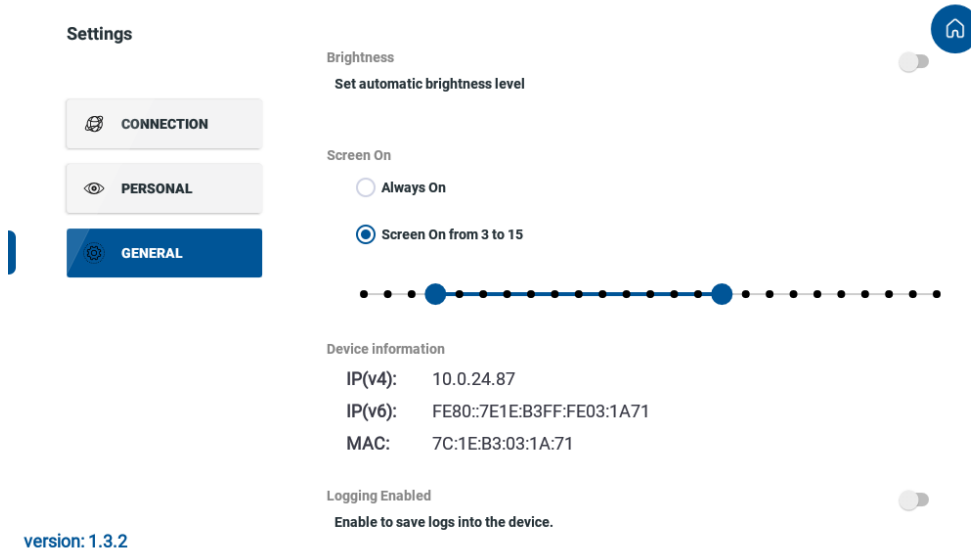

- **Brightness** – enable automatic adaptation of the display brightness level to the day/night time. The default brightness setting is the same as in the system.
- **Screen On** – choose whether the display shall be active all the time showing the meeting room information continuously, or whether the display shall be activated for a time period between the start and end points defined on the time line.
- **Device information** – display the device info.
- **Logging enable** – enable device logging. This function gives the technical support staff access to the device logs for troubleshooting purposes.

✓ **Tip**

- Refer to the [FAQ](#) for a detailed screen description of an active **2N® Meeting Room** application.

i Note

- The meeting room status is also indicated by the 2N logo backlight LED colour on the device:
 - **Green** – free
 - **Red** – occupied
 - **Orange** – waiting for meeting confirmation

 **Warning**

- Once the **2N® Meeting Room** application is activated, the unit does not answer any calls and **2N® Meeting Room** is the only application running on the unit. The reason why **2N® Indoor Touch 2.0** cannot be called while the application is active is to avoid unwanted calls and keep the meeting room events displayed all the time. The application always runs on the foreground and you can deactivate it either directly in the device settings after switching to the administrator mode or via the device web interface.

3.3.2.2 Wireless & Networks

This section helps you set the network connection parameters. Connection can be set via Ethernet or Wi-Fi (depending on the Part No., refer to Subs. [1.2 Differences between Models and Associated Products](#)).

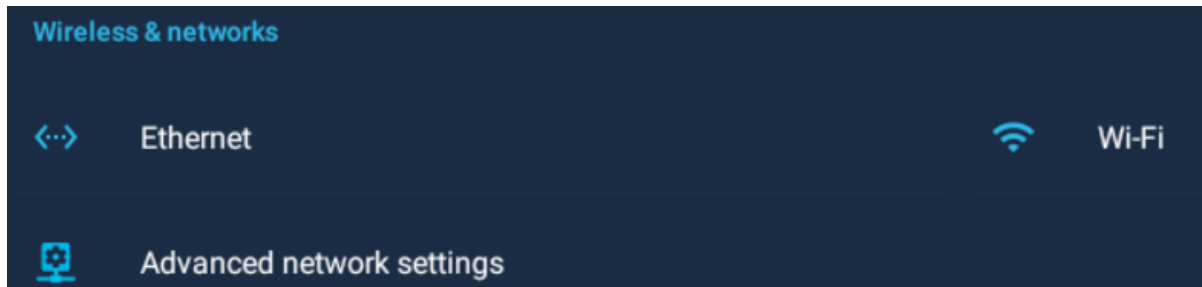

- **Wi-Fi** – disable/enable the Wi-Fi connection.
- **Ethernet** – disable/enable the Ethernet connection.
- **Advanced network settings** – display the network connection mode.

Note

- Ethernet can be used together with Wi-Fi.
- By disabling the Ethernet connection you do not switch off the device when PoE is used.

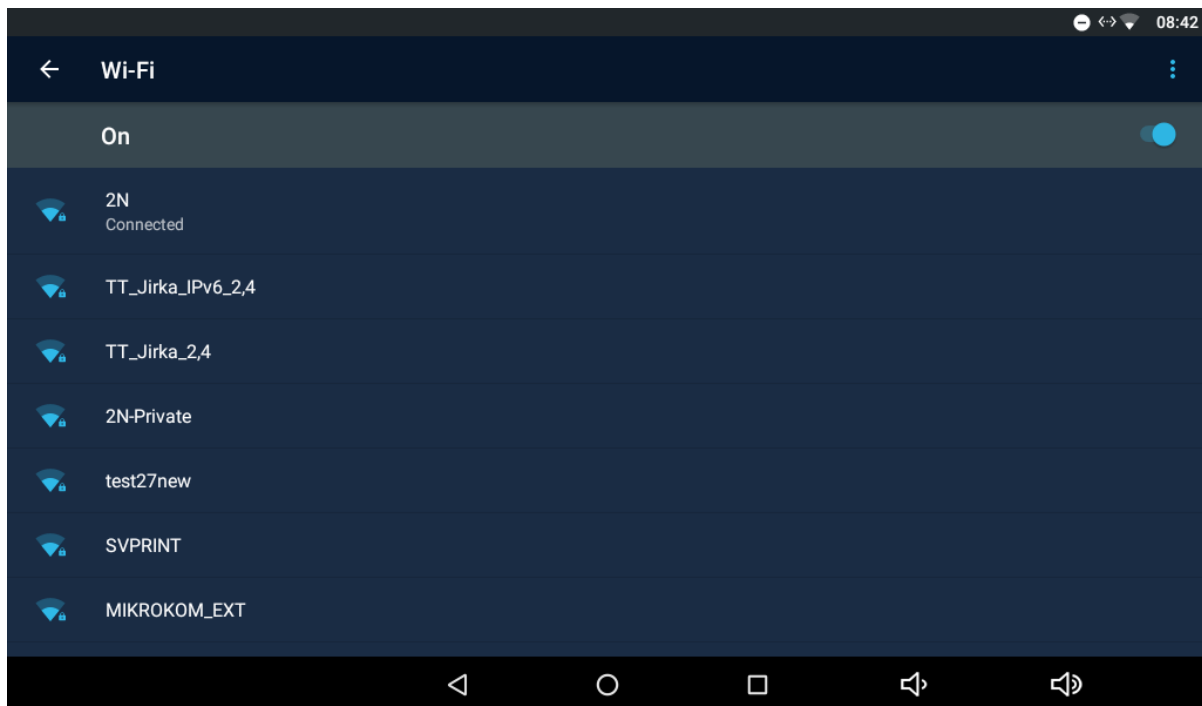

The Wi-Fi section displays the list of available Wi-Fi networks.

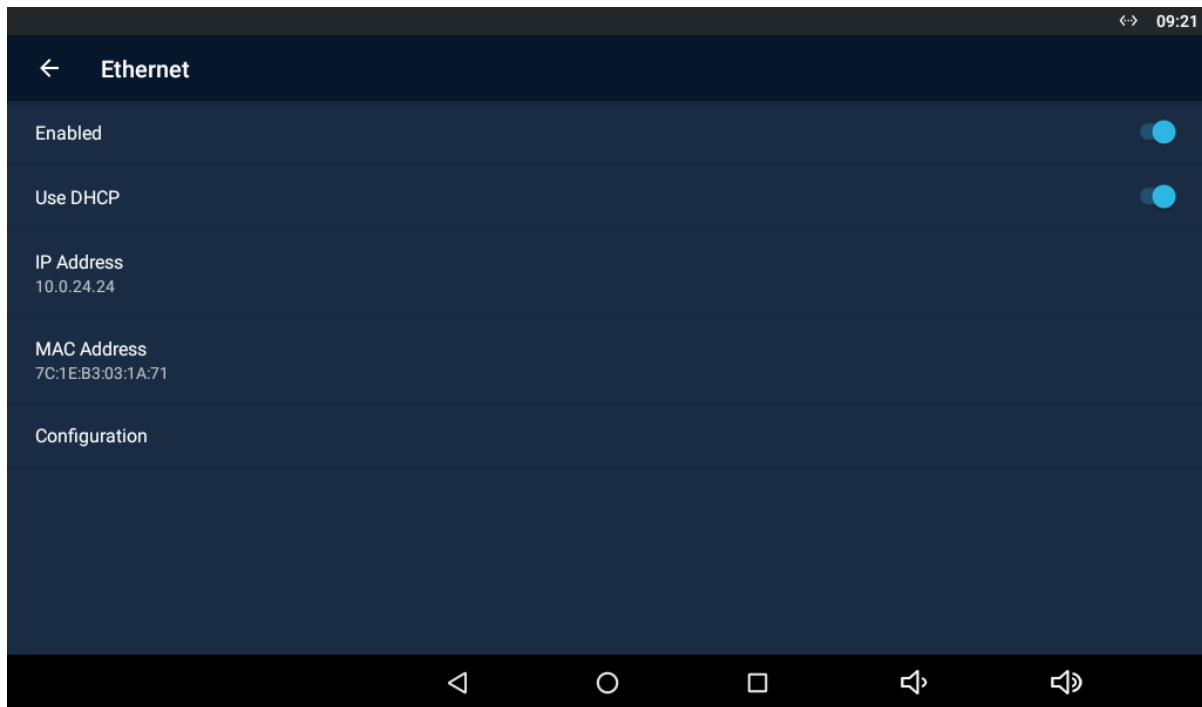

- **Enabled** – enable/disable the adapter.
- **Use DHCP** – enable/disable the DHCP client.
- **IP Address** – display the IP address.
- **MAC Address** – display the MAC address.
- **Configuration** – configure the Ethernet manually.

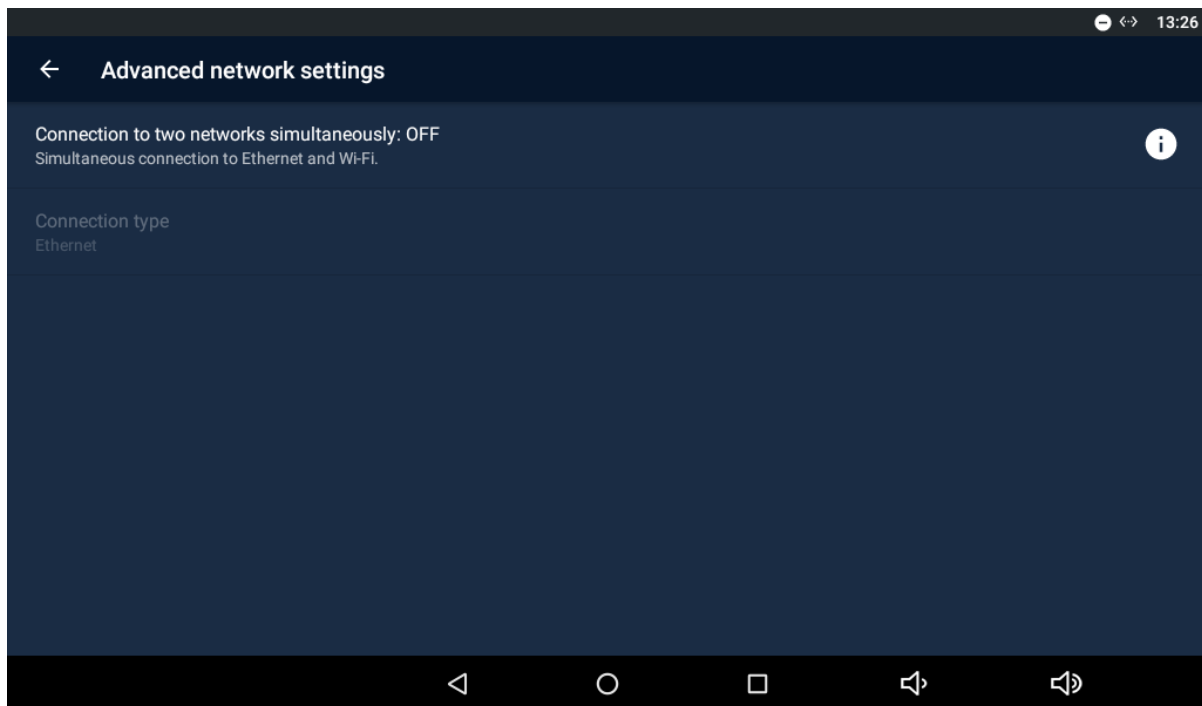

- **Connection to two networks simultaneously** – display the Ethernet + Wi-Fi connection state.
- **Connection type** – display the Internet connecting network.

3.3.2.3 Security

This subsection describes the administrator security settings.

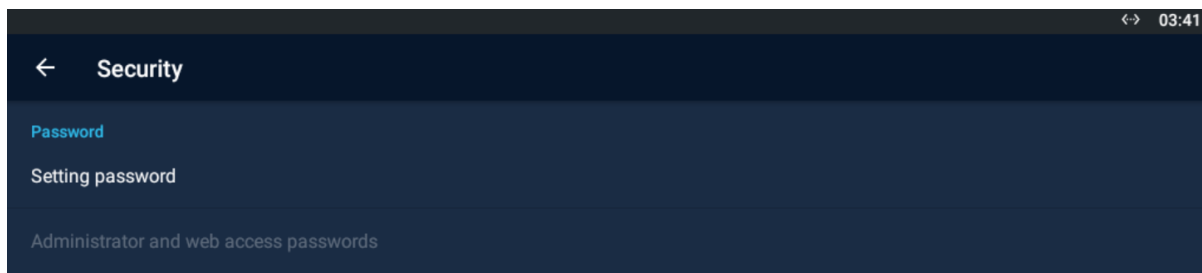

PASSWORD

- **Setting password** – set the access password type for the Settings:
 - **None** – no access password is required.
 - **Password** – set a password containing at least four letters.
 - **PIN** – set a code containing at least four digits.
- **Administrator and web access password** – set the administrator mode and web interface access password.
 - **Use separate web access password** – set separate passwords for the administrator mode and device web interface.
 - **Administrator password** – set the administrator access password.

- **Web access password** – set the web interface access password.



SCREEN LOCK

- **Screen lock** – set the screen lock password type. The screen lock is activated after the sleep mode timeout set in the Device / Screen / Sleep mode menu elapses.
 - **None** – no screen lock.
 - **Pattern** – set the screen lock deactivation gesture.
 - **PIN** – set the numeric PIN for screen lock deactivation.



UNKNOWN SOURCES

- **Allow application installation from unknown sources** – allow installation of applications from unknown sources.

3.3.2.4 Language & input

This subsection describes the administrator options.



- **Language** – set the language for the texts to be displayed.
- **Spell checker** – enable/disable the spell checker function.
- **Personal directory** – add terms of your own including optional abbreviations to the dictionary.

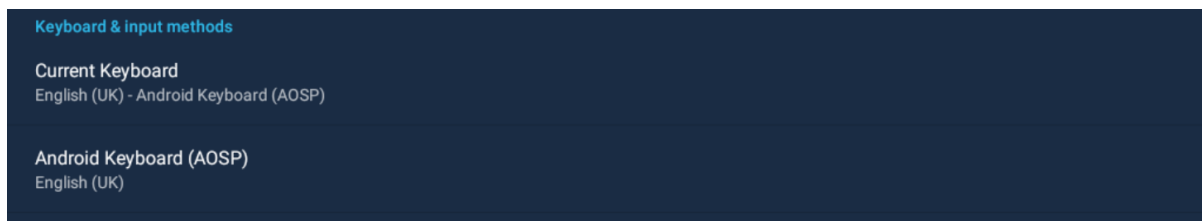

KEYBOARD & INPUT METHODS

- **Current Keyboard** – set the keyboard type.
- **Android Keyboard (AOSP)** – set the additional parameters of the Android keyboard.

3.3.3 Intercoms

This subsection describes how to configure the pre-installed **Intercoms** application.

- [3.3.3.1 General Settings](#)
- [3.3.3.2 Call Settings](#)
- [3.3.3.3 My2N/SIP Configuration](#)
- [3.3.3.4 Video](#)
- [3.3.3.5 Recorder](#)
- [3.3.3.6 Input and Output](#)

Caution

- The Intercoms application is deactivated while the device is in the Meeting Room launcher mode.

3.3.3.1 General Settings

This section helps you set the Intercoms general parameters.

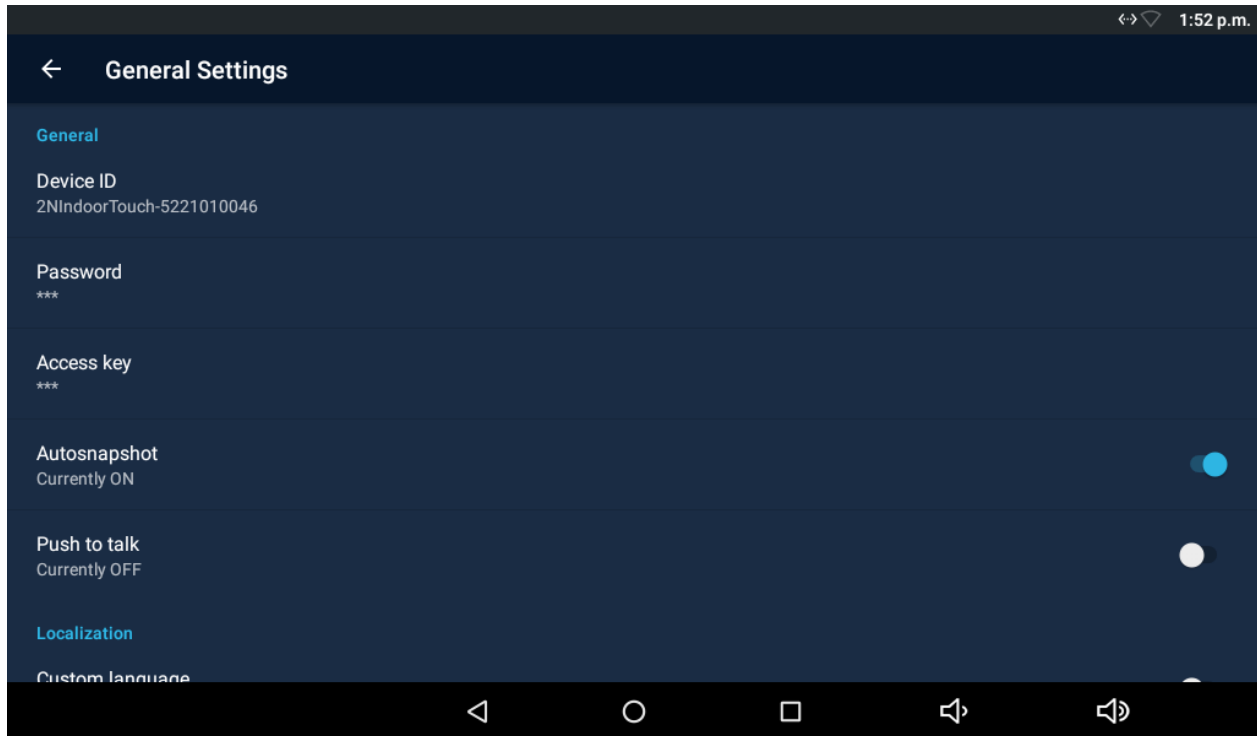

GENERAL

- **Device ID** – set the device name for **2N® IP Mobile** identification to other LAN devices.
- **Password** – set the application setting password via link click from the application.
- **Access Key** – set the **2N IP intercom** authentication password.

✓ Tip

- Refer to faq.2n.cz for the **Access key** instructions for use.

- **Autosnapshot** – enable/disable **Autosnapshot** to acquire an image from the video preview. The image replaces the circle avatar at the added devices in the Device and Call Log menus.
- **Push to Talk** – select the communication type for one-directional half-duplex communication: ON/OFF (ON by default).
- **Multicast Discovery** – ON/OFF (ON by default). With ON, **2N® Indoor Touch 2.0** sends the info packets to the network in the multicast mode. With OFF, **2N® Indoor Touch 2.0** sends the info packets in unicast to the IP address of the 2N IP intercom to be monitored and periodically to all the 2N IP intercoms included in the LAN device list. The info packets are sent in unicast to the 2N IP intercoms only, not to other **2N® Indoor Touch 2.0** LAN devices.



LOCALIZATION

- **Custom language** – use custom modified texts, which are not part of the application package. Use JSON strings to set the language.

The custom translations are optionally available in the translationMap.json file in an external storage (physical or emulated SD card), which matches the following path:

/sdcard/hipmo-localization/translationMap.json.

The hipmo-localization folder is automatically created on the first available SD card upon the application start. If there are multiple SD cards in the device and you do not know which to use, check the SD cards for the folder upon startup.

Note

- Make sure that the file name is "**translationMap.json**" without any additional (language) extensions or insertions. For example, translationMap-cs.json is wrong.

Text File Structure

The custom translation JSON includes the data root, which is an array of translation elements:

```
{ "data": [
  translation,
  translation,
  ...
  translation
] }
```

Each translation element has the following structure:

```
{ "key": { "hint": "hint_string", "value": "translated_string" } }
```

where

- **key** – text string key (replaces name in strings.xml).
- **hint_string** – text meaning.
- **translated_string** – custom translation.

Example:

```
{ "title_call_declined": { "hint": "Call declined", "value": "Call declined" } }
```

You are recommended to edit translated_string only and not modify hint_string unless necessary.

 **Warning**

- We do not advise you to edit the **KEY** text string to avoid unexpected actions of the application.

The application searches the asset for a file that matches the current Locale setting in the device. If there is one, the application adds the keys included in the file to the map. Should there be a match, old values are replaced with new ones.

The application checks the Custom Localization switch status. If the function is on and the corresponding custom translation file is available in the device, the application adds the keys to the map as mentioned above.

 **Caution**

- Untranslated strings are displayed in English.

3.3.3.2 Call Settings

This section helps you set the call parameters.

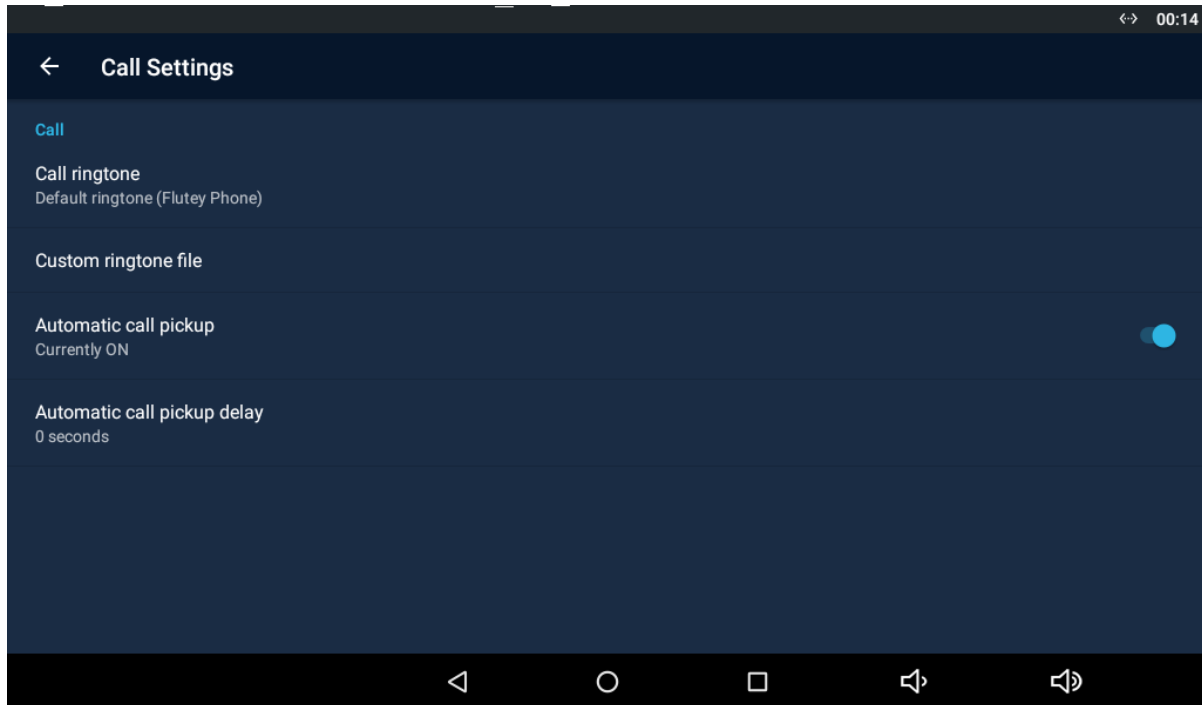

CALL

- **Call ringtone** – select the **2N® IP Mobile** default ringtone.
- **Custom ringtone file** – load an audio file to be used as the ringtone. The supported format is .wav, 15 MB, shortened to 15 s, PCM8/PCM16.
- **Automatic call pickup** – set the automatic incoming call answering.
 - **Automatic call pickup delay** – set the automatic call pickup timeout to 0–20 seconds.

3.3.3.3 My2N/SIP Configuration

This section helps you set the My2N and SIP Proxy parameters.

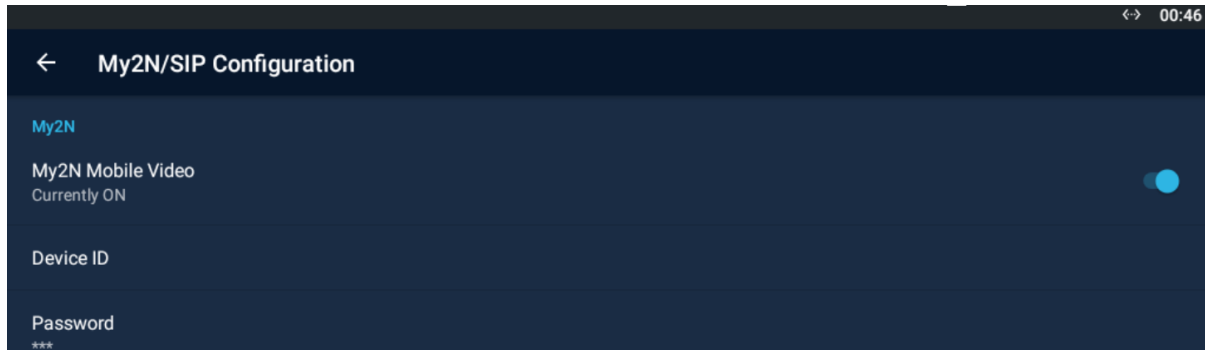

MY2N

- **My2N Mobile Video** – enable/disable **2N® IP Mobile**.
- **Device ID** – set the device ID assigned by **2N® IP Mobile**.
- **Password** – set the device password for **2N® IP Mobile** connection, generated automatically.

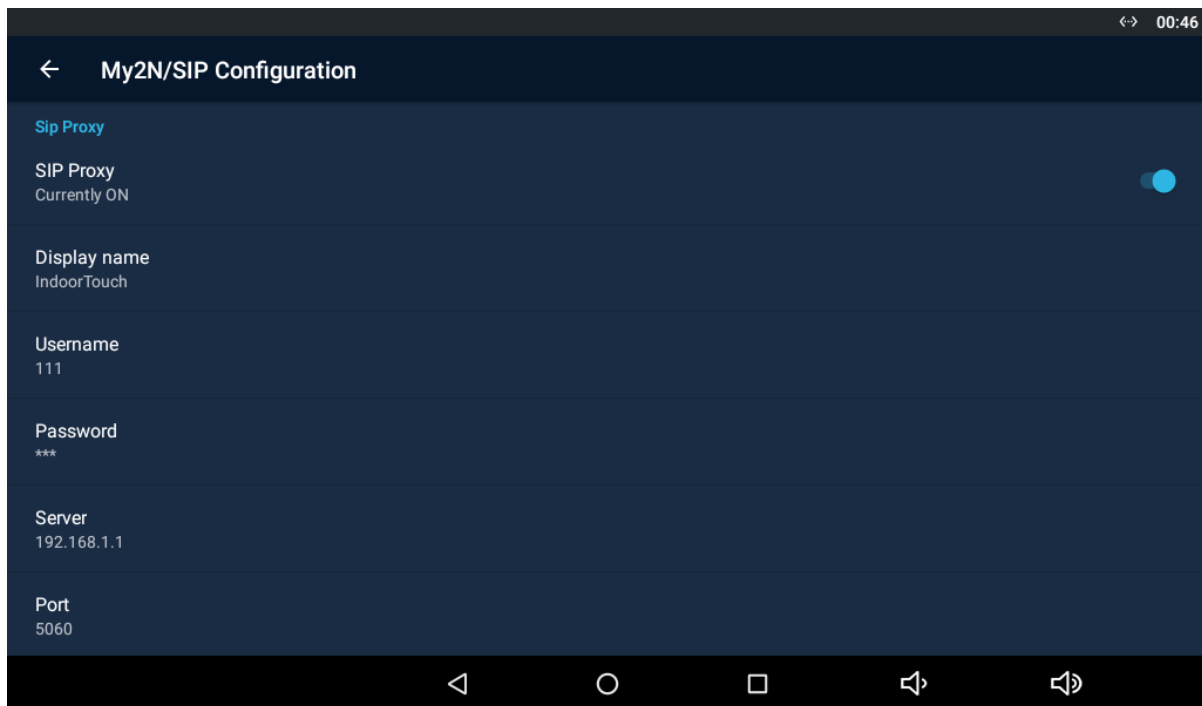

SIP PROXY

- **SIP Proxy** – enable/disable the SIP Proxy.
- **Display name** – set the account name to be displayed in the application.
- **Username** – set the SIP Proxy server username.
- **Password** – set the SIP Proxy server user password.
- **Server** – set the SIP Proxy server IP address/domain name.
- **Port** – set the SIP Proxy server port (default is 5060).
- **Transport** – select the transport protocol: TCP or UDP.

SIP REGISTRAR

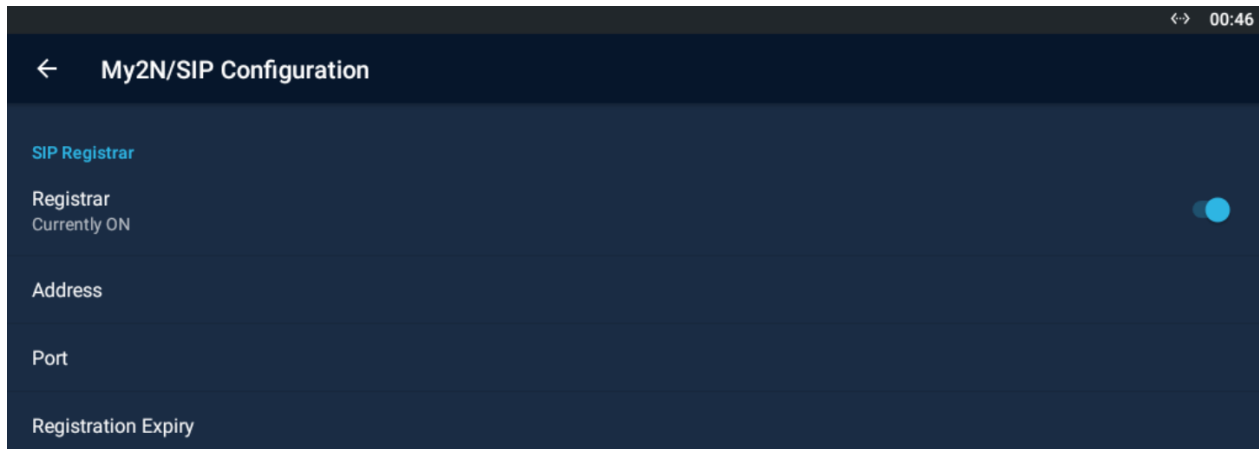

- **Registrar** – set the SIP Proxy IP address or domain name.
- **Address** – set the SIP Registrar IP address or domain name.
- **Port** – set the SIP Proxy port (typically 5060).
- **Registration Expiry** – define the registration expiry, which affects the network and SIP Registrar load by periodically sent registration requirements. The SIP Registrar can modify the expiry limit without letting you know.

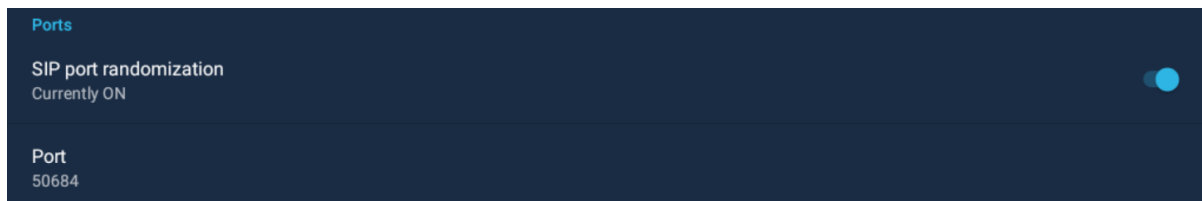

PORTS

- **SIP port randomization** – a randomly generated port where the application listens. When the setting is changed, re-registration with the SIP Proxy or My2N is made.
- **Port** – set the selected SIP port manually if SIP port randomisation is enabled.

✓ Tip

- Refer to faq.2n.cz for SIP Proxy call settings.

 **Warning**

- The SIP Proxy and My2N modes cannot be operated at the same time.

3.3.3.4 Video

This section helps you set the video parameters.

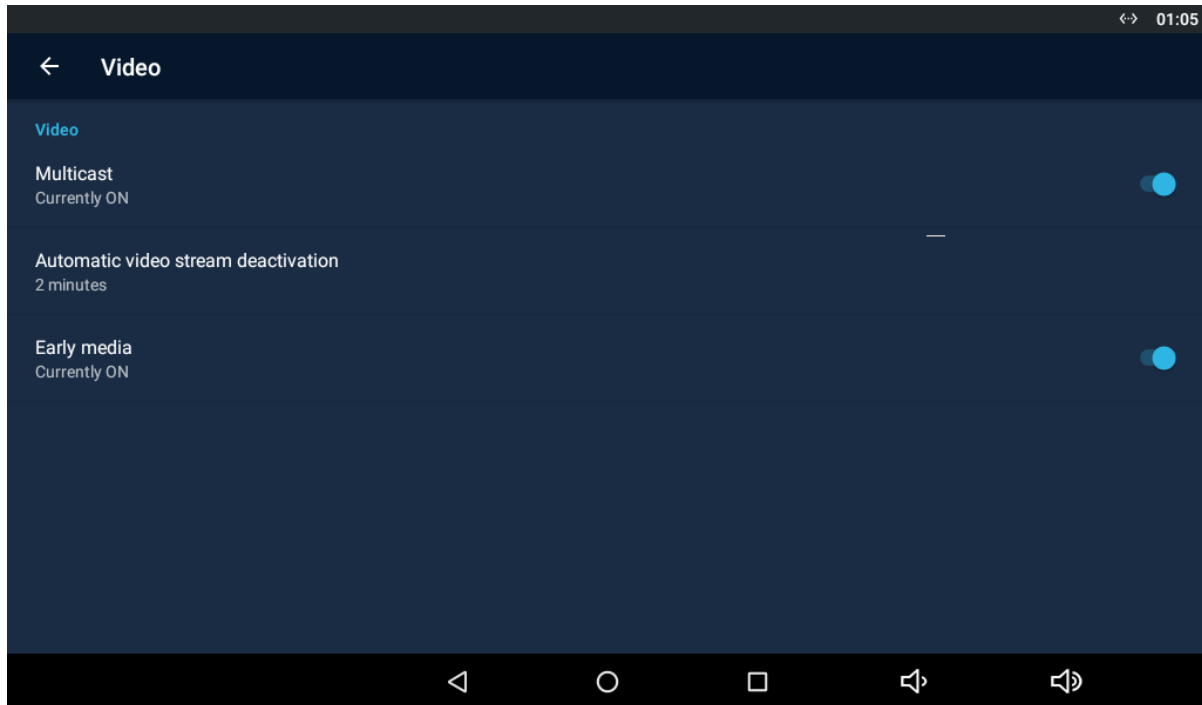

VIDEO

- **Multicast** – select the video stream transmission type from a **2N IP intercom**.
- **Automatic video stream deactivation** – set the time during which the video stream preview of the **2N IP intercom** selected in the Device section is displayed.
- **Early media** – enable/disable video stream transmission during an incoming call ringing from the devices registered with the SIP Proxy.

✓ Tip

- Refer to faq.2n.cz for Multicast/Unicast details.

3.3.3.5 Recorder

This section helps you set the recorder parameters.

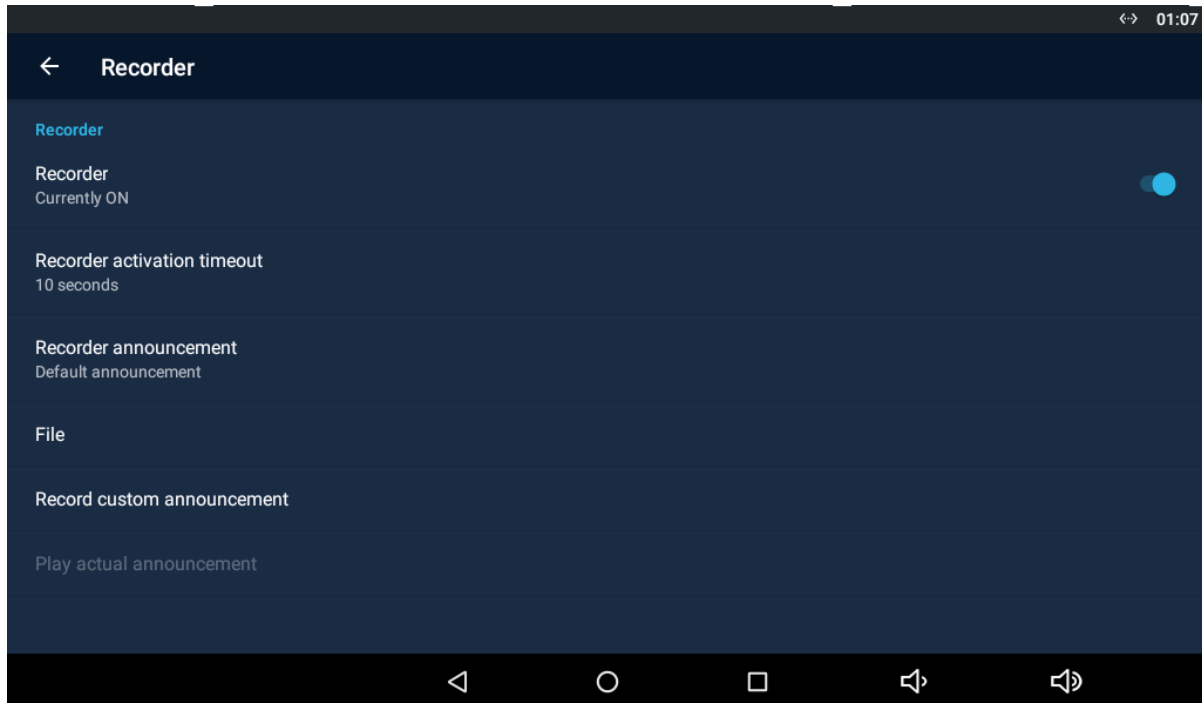

RECORDER

- **Recorder** – enable/disable the recorder function.
- **Recorder activation timeout** – the recorder is activated after the set incoming ringing timeout elapses.
- **Recorder announcement** – set the announcement to be played.
 - **Default announcement** – part of the 2N® IP Mobile package.
 - **Announcement from file** – select an announcement from a file.
 - **Recorded announcement** – select an announcement loaded in the Load user announcement section of 2N® IP Mobile.
- **File** – display the file directory structure.
- **Record custom announcement** – use this function to load an announcement of your own to be played by the recorder. The supported format is .wav, 15 MB, shortened to 15 s, PCM8/PCM16.
- **Play current announcement** – play the currently set and active announcement.

 **Note**

- The maximum recorder announcement length of time is 20 s.

 **Caution**

- If you enable the **Recorder**, the call is answered and recorded **via 1 device only**. If you set the **Recorder** for two or more devices in one LAN or called group, the call is answered and recorded via the device that was the first to pick up the call (if the same Recorder activation timeout is set for all the devices), or via the device that is assigned the lowest **Recorder activation timeout**. In heavy-traffic networks, there may be a delay during call setups and so it cannot be guaranteed that the call will be picked up and recorded by one and the same device.

3.3.3.6 Input and Output

This section helps you set the input/output parameters.

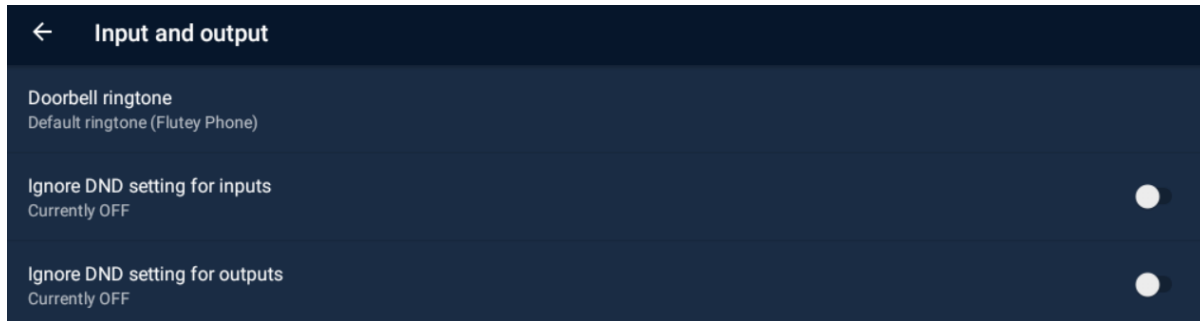

- **Doorbell ringtone** – choose the default user doorbell ringtone. The tone length is set to 10 s at doorbell activation.
- **Ignore DND setting for inputs** – allow this parameter to ignore the DND mode at input activation.
- **Ignore DND setting for outputs** – allow this parameter to ignore the DND mode at output activation.



Input / Output Configuration – define which input is related to which output and specify its function.

- **Application reacts to the following inputs** – select the input to be used, both the inputs can be used simultaneously.
 - **Input 1,2** – activate the doorbell button input.
- **Application reacts to the following outputs** – select the output to be used, both the outputs can be used simultaneously.
 - **Output 1,2** – activate the doorbell device input, e.g. for light, siren, speaker.
 - **Incoming call notification** – when the doorbell button is pressed, a notification is displayed on the device and acoustic signaling is activated.

- **Activation option at incoming call** – when the doorbell button is pressed, a notification is displayed on the device, acoustic signaling and the remote control option becomes available for activation of connected input locks as set for the user.

-  – use the pencil icon to give user names to the inputs and outputs.

✓ Tip

- Make sure that the wiring diagram shown on the device motherboard is kept to make the system work properly. Refer to Subs. [2.1 Before You Start](#) for motherboard details.
- Refer to [here](#) for doorbell button connection details.
- Refer to [here](#) for relay connection details.

ⓘ Note

- All doorbell calls including the incoming and missed notifications are stored in the call list.

⚠ Caution

- If a user fails to unlock the door lock during the ringing notification, the lock can be opened subsequently in the missed event detail in the call list.
- A collision occurs whenever both the doorbell buttons are pressed sequentially within 10 s. When the second doorbell button rings while the first doorbell button is being notified, a notification is displayed providing the option to activate the connected inputs or hiding the notification by pressing OK. After the hiding or input activation confirmation, the user returns to the notification of the first doorbell button pressed.
- When both the inputs are activated and one and the same doorbell button is repressed within 10 s, the first notification is included as missed in the call list.

3.4 Device Upgrade

There are two ways how to upgrade **2N® Indoor Touch 2.0**: using an SD card or via the device web interface.

SD card upgrade procedure:

1. Download the latest **2N® Indoor Touch 2.0** Full Upgrade firmware from www.2n.cz.
2. Get a microSD card of the maximum capacity of 16 GB and with the FAT32 file system.
3. Copy the downloaded *.ZIP firmware into the root directory of an attached SD card (naming the file **upgrade.zip**).

4. Insert the SD card in the SD card slot on the left side of **2N® Indoor Touch 2.0** (refer to [2.1 Before You Start](#)).
5. Reset the device as follows:
 - a. Press the backside Reset button shortly (refer to [2.1 Before You Start](#)), or
 - b. Press the Restart button in the System / Data Backup and Recovery configuration section.
6. If **2N® Indoor Touch 2.0** detects the right file, the upgrade process will run automatically. If not, an error message is displayed.
7. Remove the SD card after the upgrade is complete and choose one of the following options:
 - a. Click the display to restart the system.
 - b. Hold your finger on the screen for 5 seconds to reset the factory values.

 **Warning**

- Never remove the SD card during upgrade to avoid device damage.
- If you want to interrupt the upgrade process, do it within the first 10 seconds as invited. Upgrade cannot be aborted later. Remember to remove the SD card after upgrade abort to avoid upgrade re-attempt upon the next startup!

Web interface upgrade procedure:

1. Download the latest **2N® Indoor Touch 2.0** firmware from www.2n.cz.
2. Expand the package downloaded.
3. Enter the device IP address into the browser address row to enter the **device** web interface.
4. Log in and go to the Maintenance tab.
5. Select Firmware upgrade and load the *.zip file included in the firmware package in the wizard.
6. Having completed file loading and verifying, click Upgrade.
7. The device will get restarted and upgrade will be executed automatically.

 **Caution**

- The upgrade process may take up to 10 minutes or more.
- Never disconnect the device from the electric power supply during upgrade to avoid device damage!
- The first system startup after a successful upgrade may take up to a few minutes.
- User data is not deleted during the upgrade process.

4. Intercoms Applications Configuration

This section describes configuration of the pre-installed **Intercoms** application.

Here is what you can find in this section:

- [4.1 Application Description](#)
- [4.2 Application Environment and Configuration](#)
 - [4.2.1 Device](#)
 - [4.2.2 Call Log](#)
 - [4.2.3 Dial Pad](#)
 - [4.2.4 Settings](#)
- [4.3 Notifications in 2N® Indoor Touch Environment](#)
- [4.4 Application Use](#)
 - [4.4.1 LAN Calls](#)
 - [4.4.2 SIP Proxy Server Calls](#)
 - [4.4.3 2N® Mobile Video Calls](#)
- [4.5 Supplementary Information](#)
 - [4.5.1 Troubleshooting](#)

4.1 Application Description

2N® IP Mobile is an application designed for video calls between the **2N IP intercoms** and **2N® Indoor Touch 2.0** devices.

2N® IP Mobile is part of the **2N® Indoor Touch 2.0** firmware.

2N® IP Mobile sets up calls between the **2N® Indoor Touch 2.0** devices.

2N® IP Mobile sets up calls between a Smartphone and **2N® Indoor Touch 2.0** device.

2N® IP Mobile sets up calls via the **2N® Mobile Video** cloud solution.

2N® IP Mobile sets up SIP Proxy calls for other SIP supporting devices and applications.

Caution

- Always use the latest firmware in your **2N IP intercom** or **2N® Indoor Touch 2.0** device to make the application work perfectly!

4.2 Application Environment and Configuration

Once launched, **2N® IP Mobile** displays the Device screen:

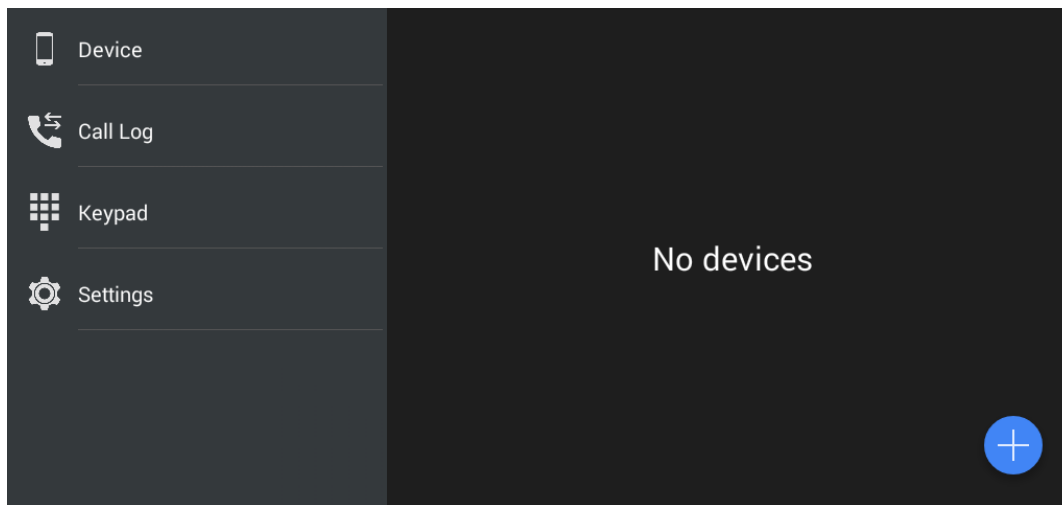

The main menu includes the following items:

- **Device** – list of added devices: **2N IP intercoms**, **2N® IndoorTouch 2.0**, **2N® Mobile Video** or, if SIP Proxy is used, any other SIP supporting device.
- **Call Log** – list of all accomplished incoming/outgoing calls.
- **Keypad** – dial a station number manually to set up a call if the application is registered with a SIP Proxy server.
- **Settings** – **2N® IP Mobile** settings.

✓ **Tip**

- The **2N® IP Mobile** settings are available via the **2N® IndoorTouch 2.0** configuration interface too.

4.2.1 Device

The Device section helps you add the **2N IP intercoms**, **2N® Indoor Touch 2.0** devices, **2N® Mobile Video** devices and devices registered with the same SIP Proxy server. The **2N IP intercoms** and **2N® Indoor Touch** devices are detected in the LAN automatically via **2N® IP Mobile**. The devices that are connected to another LAN need a SIP Proxy server and have to be added manually. You can combine adding devices from groups (LAN / Proxy / My2N).

Note



- The application does not provide simultaneous SIP Proxy server and **2N® Mobile Video** connections. Therefore, the added devices are switched too. The SIP Proxy account connection, SIP Proxy device creation and device adding make these devices saved. Once connected to **2N® Mobile Video**, the application remembers these devices and adds them to the device list after SIP Proxy reconnection. The added LAN devices are always visible in the Device menu.

Device Adding

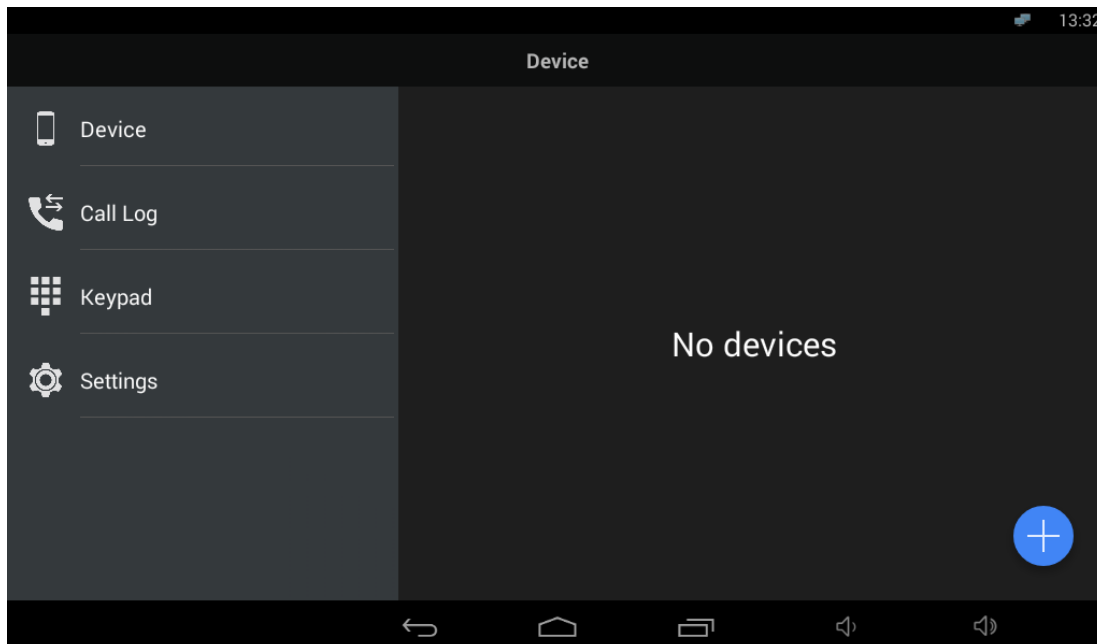
Click the  icon in the right-hand bottom corner of the Device main window to enter the device adding menu.



LAN Devices

All the **2N IP intercoms** and **2N® Indoor Touch 2.0** devices detected automatically in the same LAN are displayed in the Device/LAN main window. Click a row to remove the selected device. Each device is identified by a name and IP address. The selected device is marked . Press  to the right in the application upper toolbar to select all the devices listed. Click  to edit the device name.

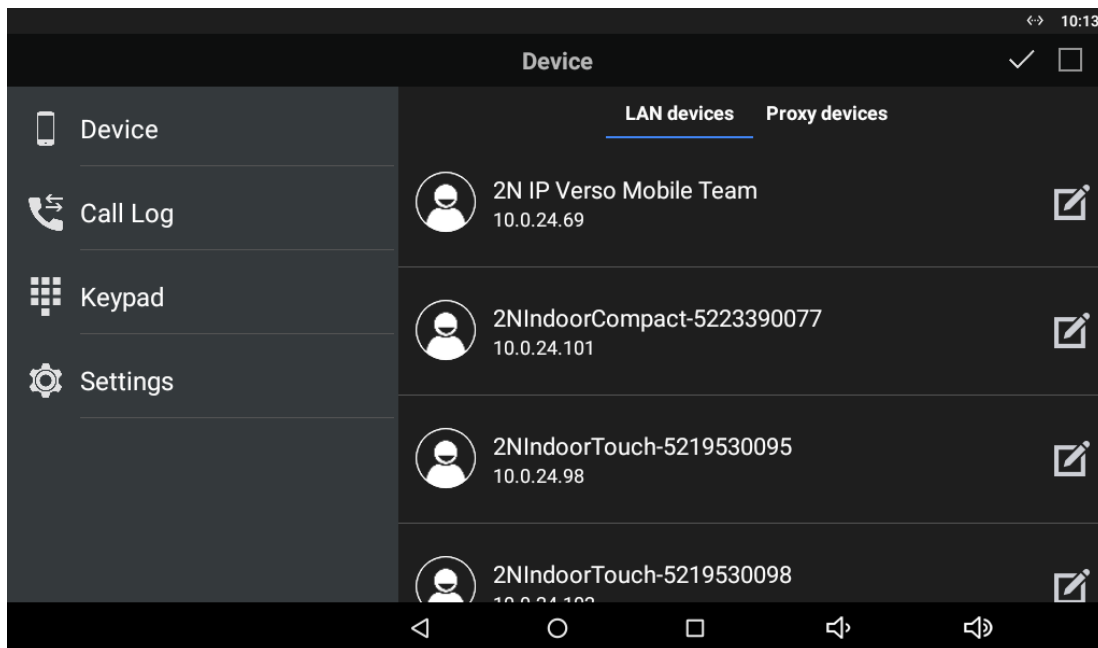

Click  to edit the device name.

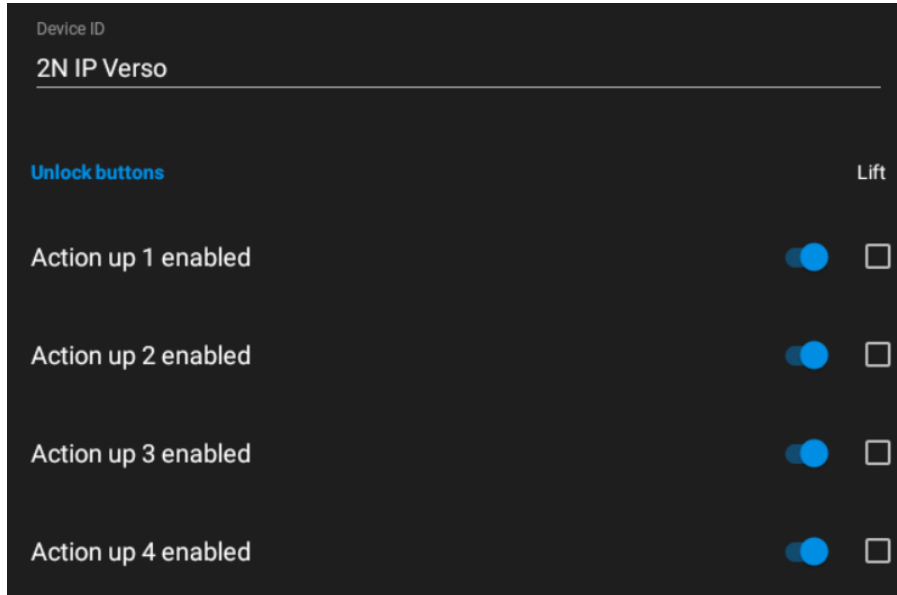

- **Device ID** – device identification.
- **Unlock buttons** – list of device buttons.
 - **Action up 1–4 enabled** – define the button(s) to be displayed.
 - **Lift** – select this option to display the selected button only during the call as a lift icon.

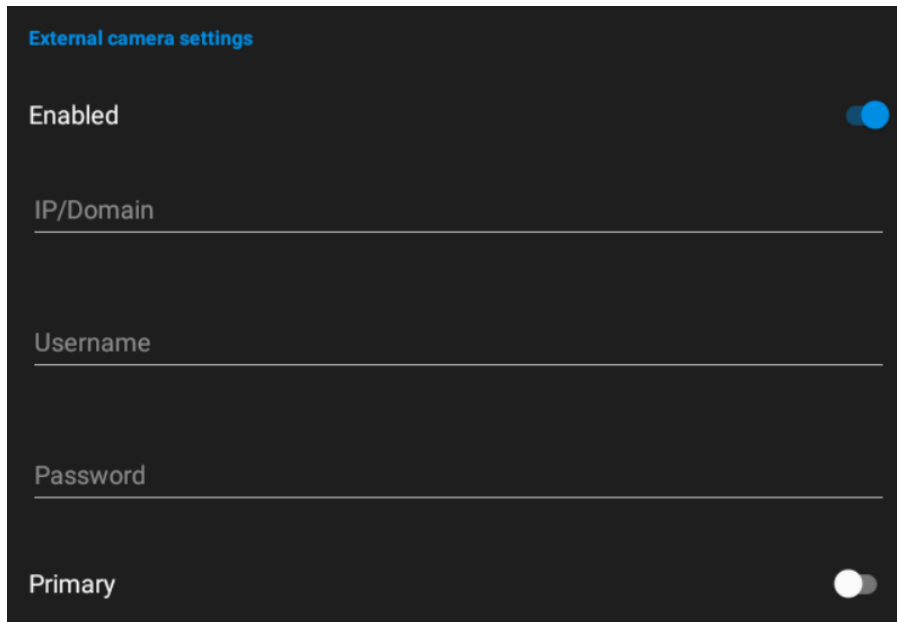

External camera settings

Enabled

IP/Domain

Username

Password

Primary

External camera settings – enter the parameters for external Axis camera connection.

- **Enabled** – enable the external camera settings.
- **IP/Domain** – set the Axis camera IP address/domain name.
- **Username** – set the Axis camera video stream login username.
- **Password** – set the Axis camera video stream login password.
- **Primary** – select the primary display: external camera or default video stream.



HTTP Protocol HTTPS Protocol

- **HTTP Protocol / HTTPS Protocol** – set the authorisation protocol.

Click to the right in the upper panel to save the selected LAN devices. The application moves back to the Device menu to display the selected devices.

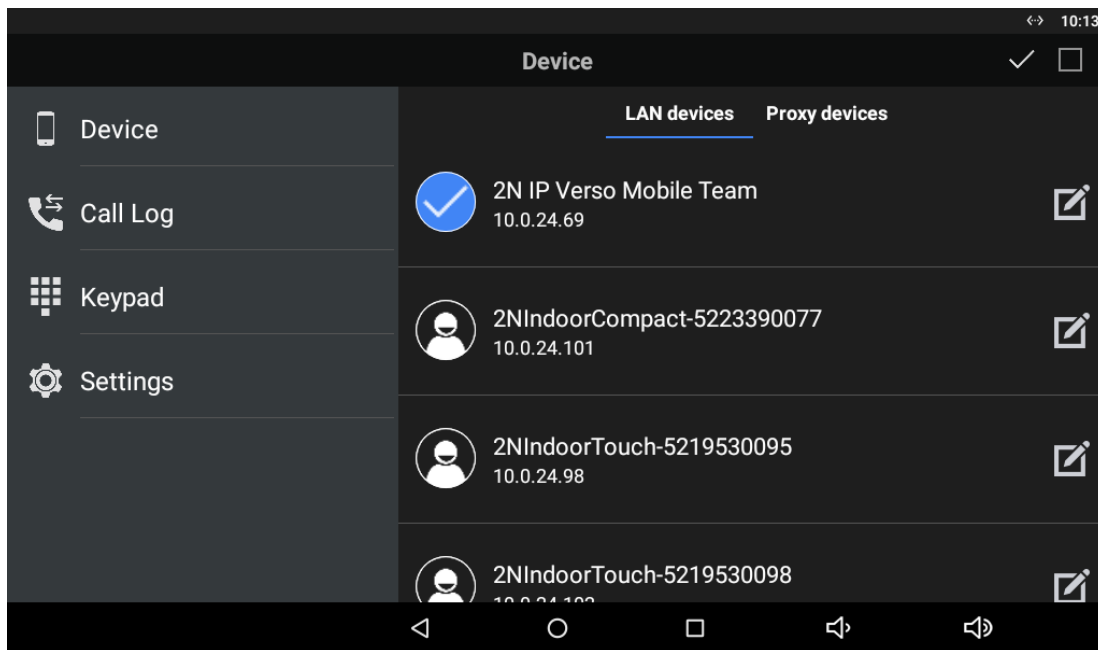

Proxy Devices

To become a SIP Proxy device, the device has to be registered with a SIP Proxy server.

Note

- The application does not allow you to add, create or edit a SIP Proxy device unless correctly connected to a SIP Proxy server.

Proxy Registration

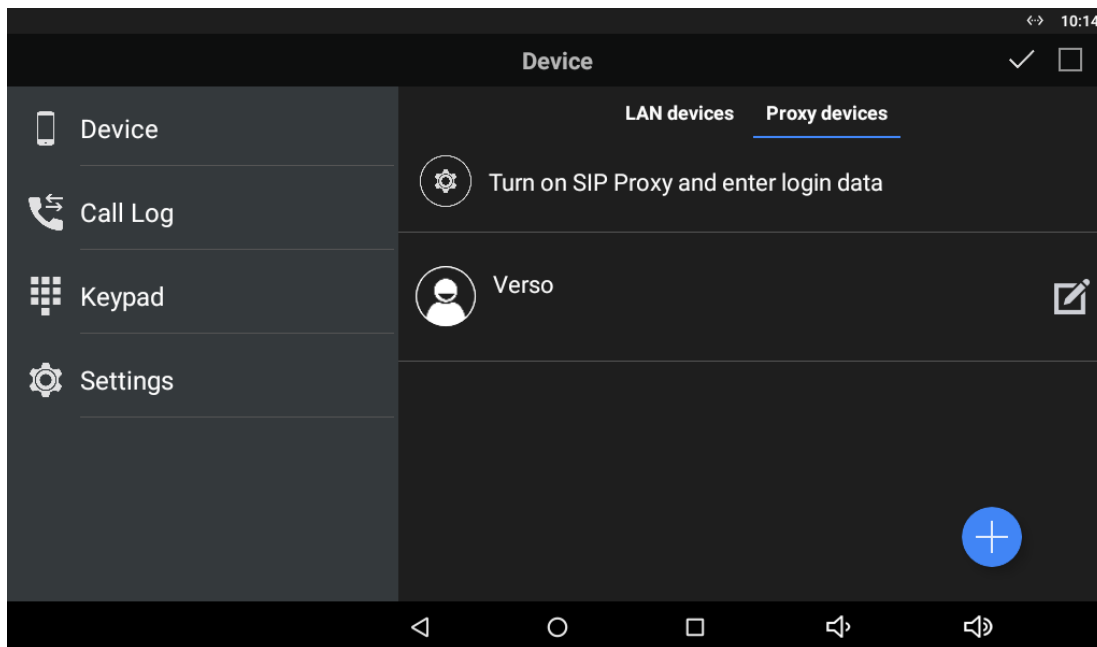

2N® IP Mobile and SIP supporting devices can communicate with each other only if registered with the same SIP Proxy server.



Click the row marked with  to redirect the application to the My2N/SIP configuration menu. Set the SIP Proxy state to ON and edit the SIP Proxy server connecting parameters. Refer to 4.2.2 SIP Proxy Server Calls for details.

Set the parameters correctly to complete the **2N® IP Mobile** registration with a SIP Proxy server. Check the notification icon in the Device main menu for the registration status:

1.  – The application has been successfully registered with a SIP Proxy server.





2.  – The application is trying to register itself with a SIP Proxy server, yet unsuccessfully so far.
3.  – The SIP Proxy server registration is inactive due to the SIP Proxy server rejection or unavailability.

 **Caution**

- The **2N® IP Mobile** application requires 60 s as the minimum registration expiry time. If the expiry time is shorter, the application may keep disconnecting from the SIP Proxy server.

Proxy Device Adding

Once **2N® IP Mobile** is successfully connected to and registered with the SIP Proxy server, you can add SIP Proxy devices to the list manually. Again, click  in the right-hand bottom corner of the Device main window to enter the device adding mode. Then use the tab below the application title row to switch the window to Proxy devices.

The selected device is marked . Click  to the right in the application upper toolbar to select all the devices listed. Click  to edit the device name. Click  to save the selected Proxy devices. The application moves to the Device menu to display the selected devices.

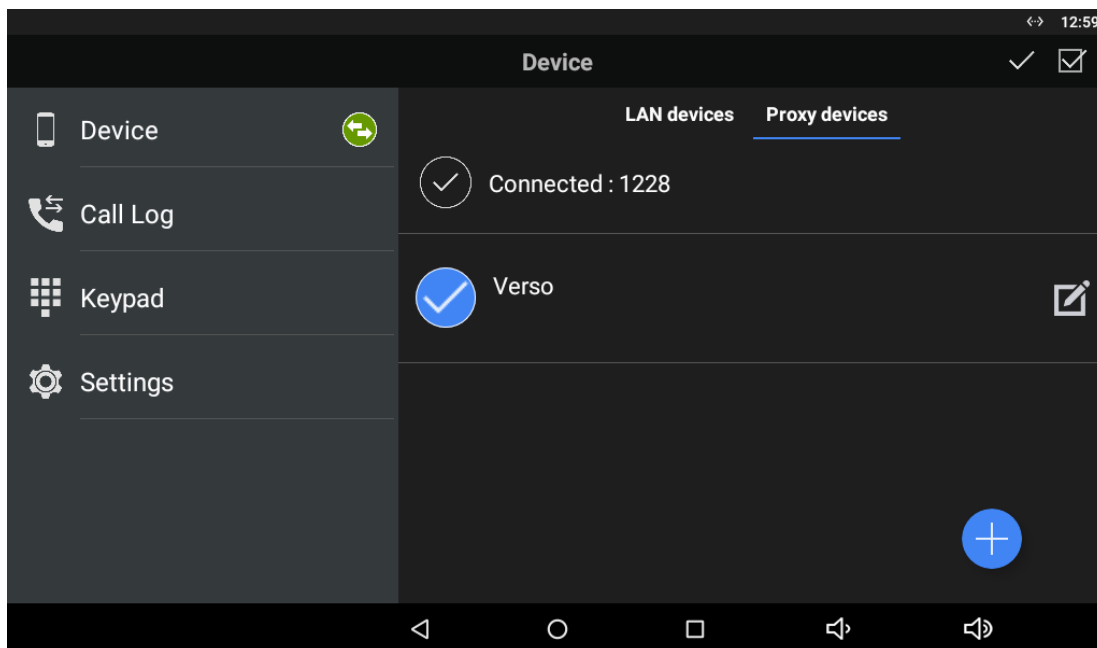

Click  to add a SIP Proxy device.

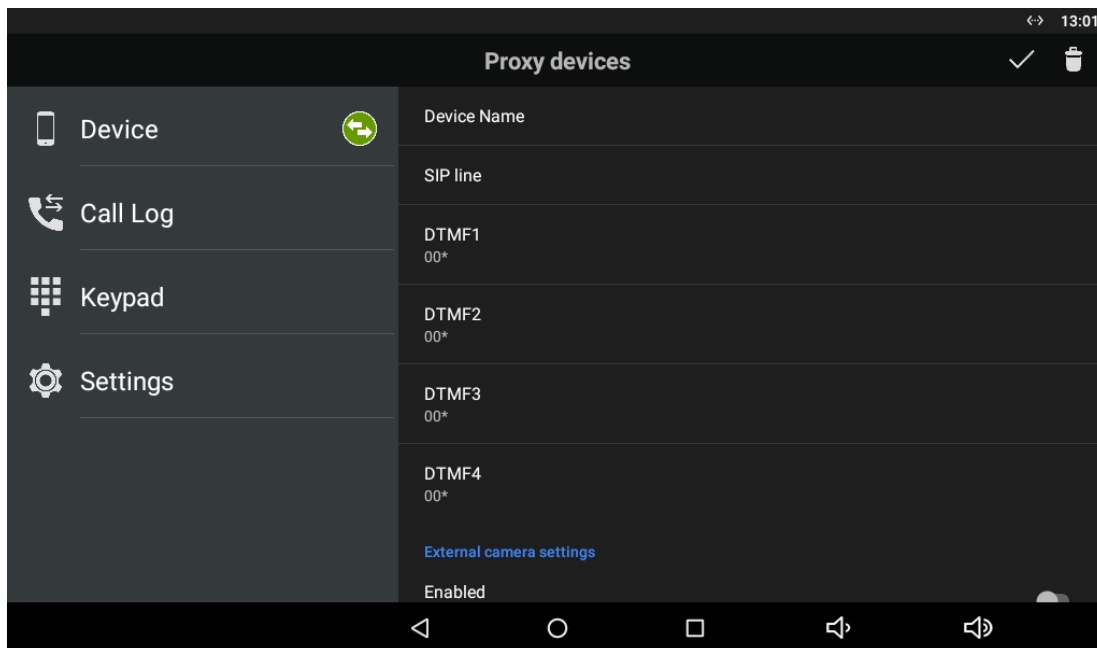

Complete the following parameters:

- **Device name** – set the device name for identification in **2N® IP Mobile**. Used for application only.
- **SIP line** – set the line to be dialled by **2N® IP Mobile** for an outgoing call.
- **DTMF1-4** – set the DTMF to be sent when lock 1-4 is pressed. Used primarily for DTMF sending to the **2N IP intercoms** and unlocking.
- **External camera settings** – enter the parameters for external Axis camera connection:
 - Enabled/Disabled
 - IP/domain – set the Axis camera IP address/domain name.
 - Username – set the Axis camera video stream login username.
 - Password – set the Axis camera video stream login password.
 - Primary – select the primary display: external camera or default video stream.
 - HTTP/HTTPS Protocol – select the communication protocol.

My2N Devices

The My2N devices are devices from **2N® Mobile Video**. Like the SIP Proxy devices, the My2N devices cannot be added to the device list until the application is connected to the cloud at www.my2n.com.

Caution

- Make sure that a web account and one **2N® Indoor Touch 2.0** device at least have been created to make use of the **2N® Mobile Video** functions. Refer to faq.2n.cz for more details.

Warning

- When the 30-day Trial licence expires, purchase a licence corresponding to the count of created devices. If you fail to do so, you will not be able to log in to **2N® Mobile Video** and use cloud calls.

Connection to Service

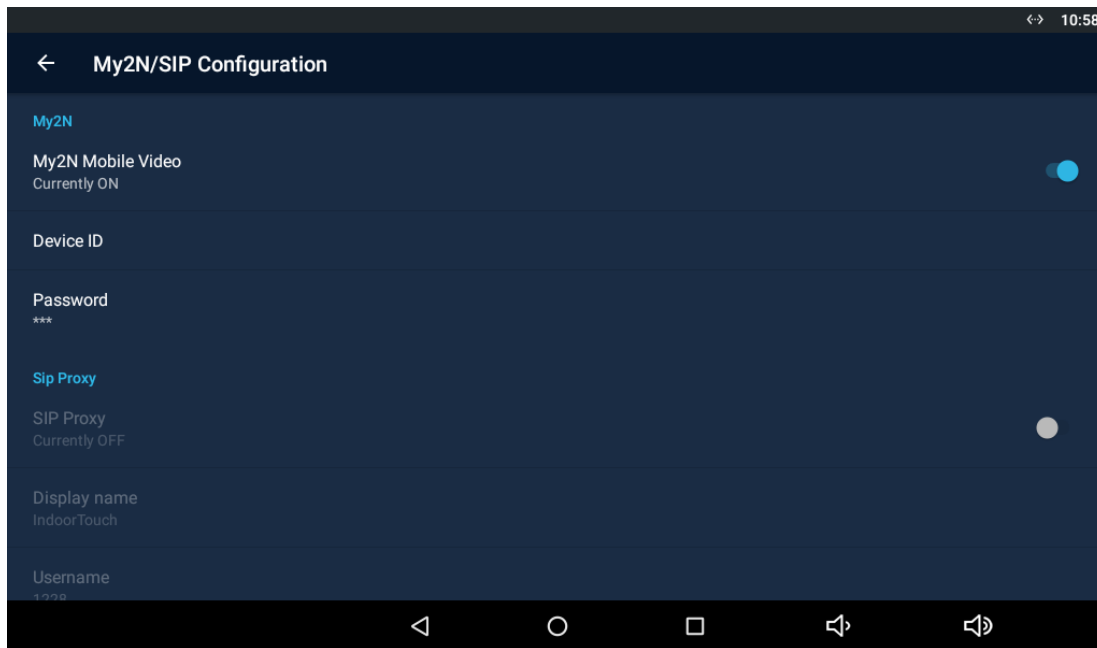

Use the application settings for **2N® Mobile Video** connection. Find the main menu Settings and turn the switch to Enabled to activate the My2N Mobile Video login row. Refer to [4.2.3 Calls via 2N® Mobile Video](#) for more details.



Upon login, the Phonebook (device list) set for this device on the service web is downloaded to the application and displayed in the My2N devices, which replaces the Proxy devices. The Phonebook is also added automatically to the Device menu.

The application indicates the **2N® Mobile Video** server connection using an icon next to the devices tab:





1.  – The application has successfully downloaded all the data and is registered with a **2N® Mobile Video** SIP Proxy server.

2.  – The application has successfully downloaded all the data and is trying to register itself with a **2N® Mobile Video** SIP Proxy server, yet unsuccessfully so far.
3.  – The application failed to connect to the **2N® Mobile Video** servers.

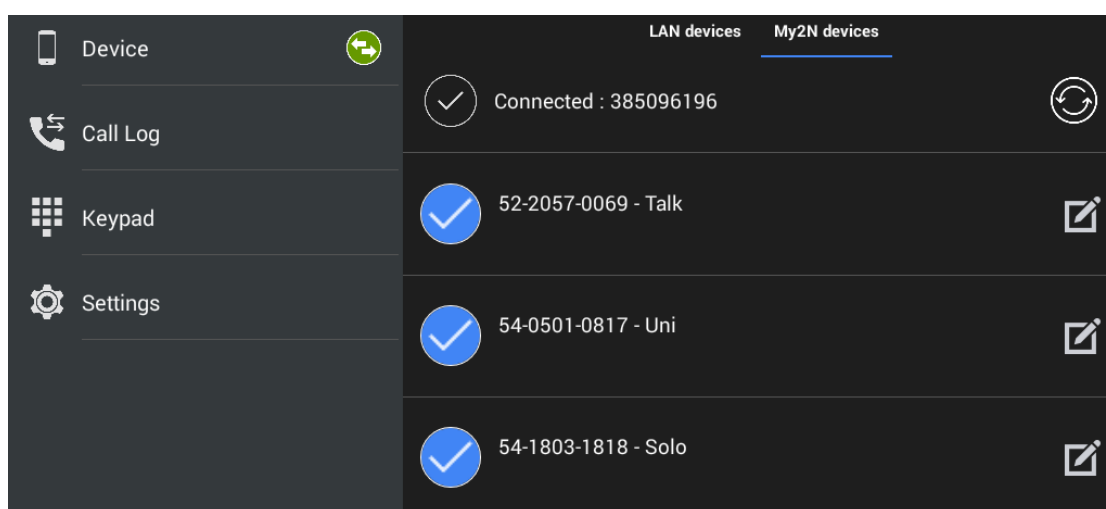
My2N Device Adding

Once **2N® IP Mobile** is successfully connected to and registered with **2N® Mobile Video**, the Phonebook download is displayed in the Device menu. You can edit the device names or remove a device from display in the Phonebook. Again, click  in the right-hand bottom corner of the Device main window to enter the device adding mode. Then use the tab below the application title row to switch the window to My2N devices.





The selected device is marked . Click  to the right in the application upper toolbar to select all the devices listed. Click  to edit the device name. Click  to save the selected My2N devices. The application moves to the Device menu to display the selected devices. Press  to redownload the Phonebook without relogging from the application.

Info



- You can only edit the My2N device name displayed in the application. The name change does not affect the device name on the service web.

4.2.2 Call Log

The **2N® IP Mobile** Call Log section displays the records of outgoing/incoming calls. The following values are available:

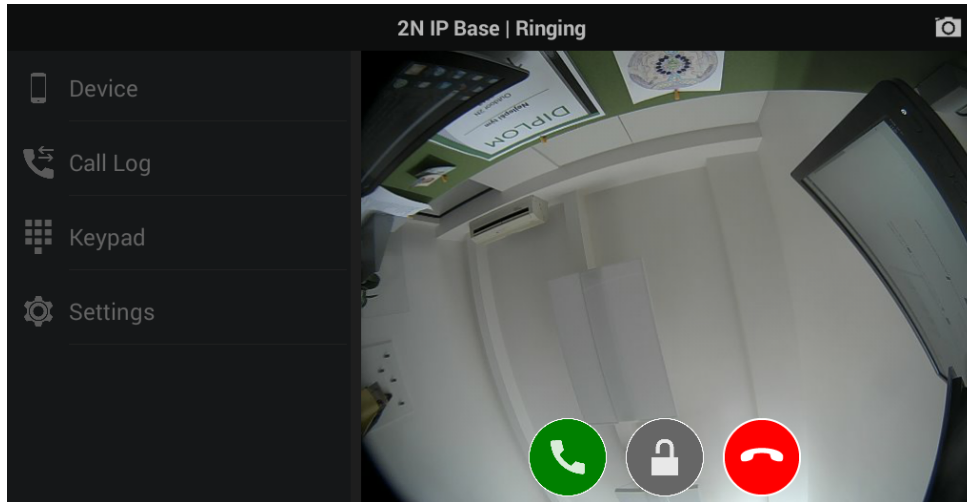
-  outgoing – outgoing call
-  incoming – incoming call
-  missed – missed call



The call icon is either a snapshot from the device or an avatar. The avatar is displayed when the Autosnapshot parameter is inactive for cameraless devices or when no snapshot was made due to a short video preview – the ringing time is set behind the bell icon (). Click  to make a callback. If the recorder is active, click  to play the incoming call record. Use the trash bin in the right-hand upper corner to delete the records.

Note

- A snapshot is only made when the video stream preview is active for about 3 seconds.
- The maximum count of Call Log items is 30 records.
- When the list is full, the oldest record is automatically deleted and replaced with the latest record.

Select a record to be shown. The records include the call length and an enlarged snapshot. Play the missed call record if available. Click  in the right-hand upper corner to export a record to a storage.

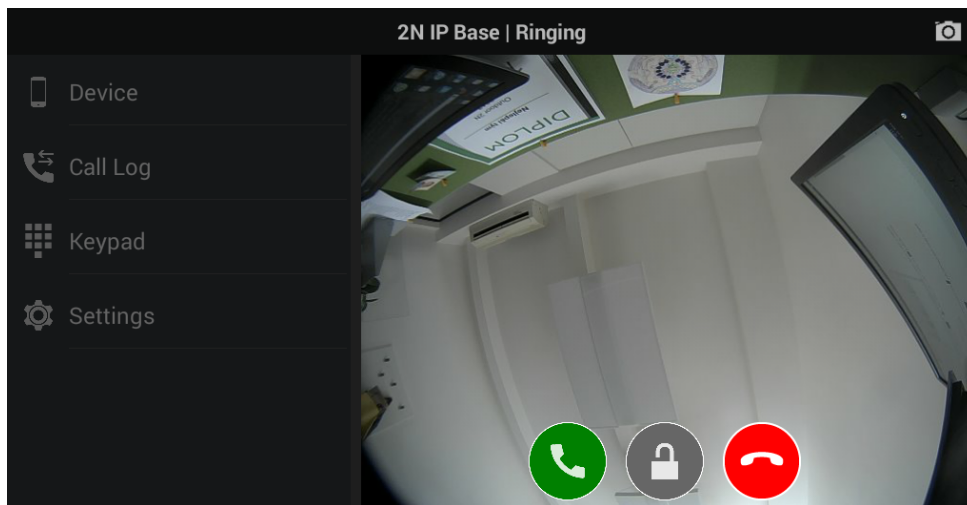

⚠ Caution

- Unanswered outgoing/incoming calls have a 0:00 call duration.

✓ Tip

- Refer to faq.2n.cz for the recorder instructions for use.

4.2.3 Dial Pad

The Dial Pad menu helps you call SIP devices by dialling the called number via a SIP Proxy server. When **2N® IP Mobile** is not registered with the SIP Proxy, the dial pad is inactive.

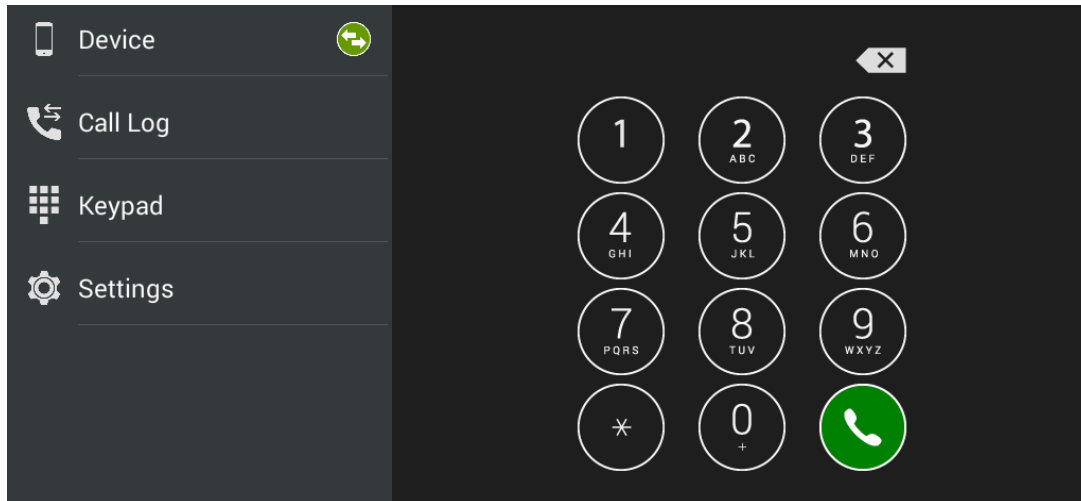

Once **2N® IP Mobile** gets registered with the SIP Proxy, the Dial Pad function becomes active.

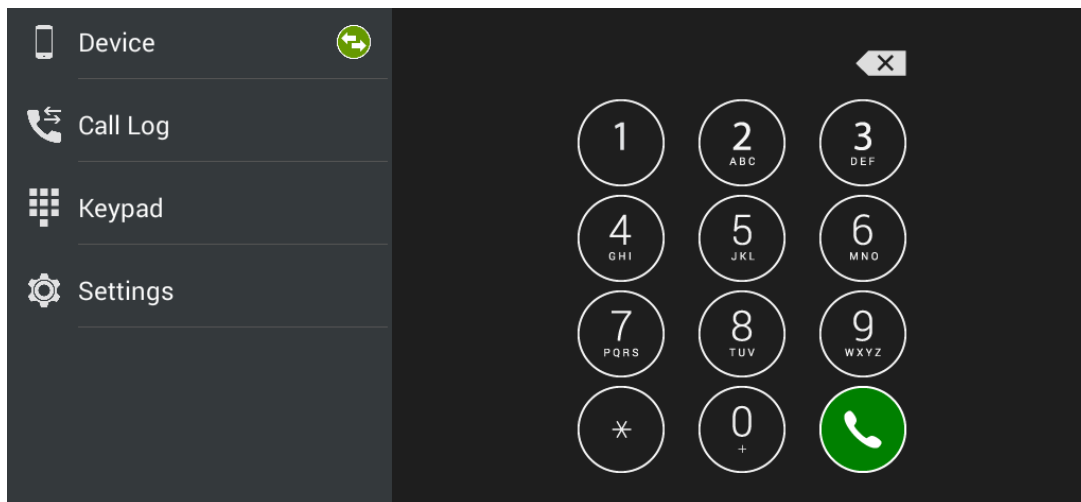

When a call is ringing via the dial pad, the avatar is displayed in case the called device does not support video stream transmission. If the called device supports video transmission, the video stream is displayed in the same way as if the call were made from a device added to the device list.

 **Caution**

- The Dial Pad does not allow tone signalling (DTMF) to be sent during a call.

4.2.4 Settings

Refer to [3.3.3 Intercoms](#) for application settings.

4.3 Notifications in 2N® Indoor Touch Environment

2N® IP Mobile uses a **2N® Indoor Touch 2.0** notification LED. The LED starts flashing red to indicate that:

- There is an unread incoming call in the application.

4.4 Application Use

This subsection provides basic instructions on how to put the application in operation for typical use.

- [4.4.1 LAN Calls](#)
- [4.4.2 SIP Proxy Server Calls](#)
- [4.4.3 2N® Mobile Video Calls](#)

4.4.1 LAN Calls



To communicate with an **2N IP intercom**, it is necessary to change a setting in the door communicator to be connected. Refer to the online [Configuration manual for 2N IP intercoms](#) or **FAQ**:

- [2N® IP Mobile v4 – How to set communication between Indoor Touch/IP Mobile and 2N IP intercom?](#)



4.4.2 SIP Proxy Server Calls

To make calls via a SIP Proxy server set the application server connection correctly in the SIP Proxy section of the Settings menu. Get the login data from the SIP Proxy server provider.

Once connected, you can dial other devices directly from the application Dial Pad or create a SIP Proxy device, click it to display the device card and start calling. Click  to start calling. Click the  icon to send the set DTMF code to the device.

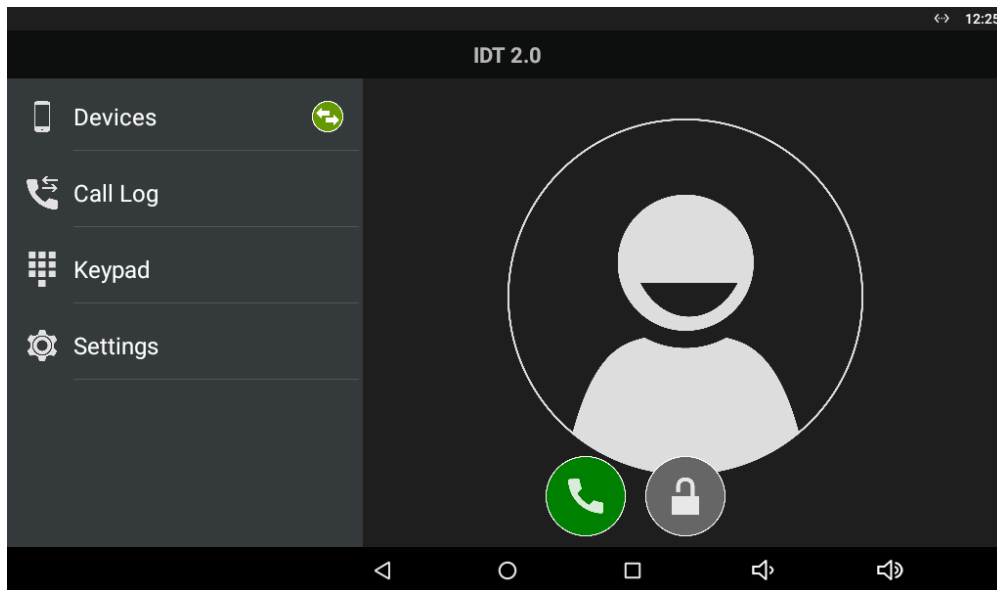

 **Tip**

- Press and hold the lock button to display the lock list (locks 1–4) to control all the locks (not only the default one).

 **Caution**

- It is impossible to send the DTMF code from the application outside a call for technical reasons. Therefore, if you press the lock outside a call in the SIP Proxy mode, a call is set up first during which the DTMF is sent automatically.
- If the **2N IP intercom** and the application are in one and the same LAN, the incoming call is always identified as a LAN call even if it goes via a SIP Proxy server. If you require SIP Proxy identification and the application and **2N IP intercom** share one and the same LAN, set a different **Access Key** password in the application.

 **Tip**

- Refer to faq.2n.cz for more details on SIP Proxy server calls.

4.4.3 2N® Mobile Video Calls

It is very easy to set the application for calling via **2N® Mobile Video**. All you have to do is set correct login data in the application settings:

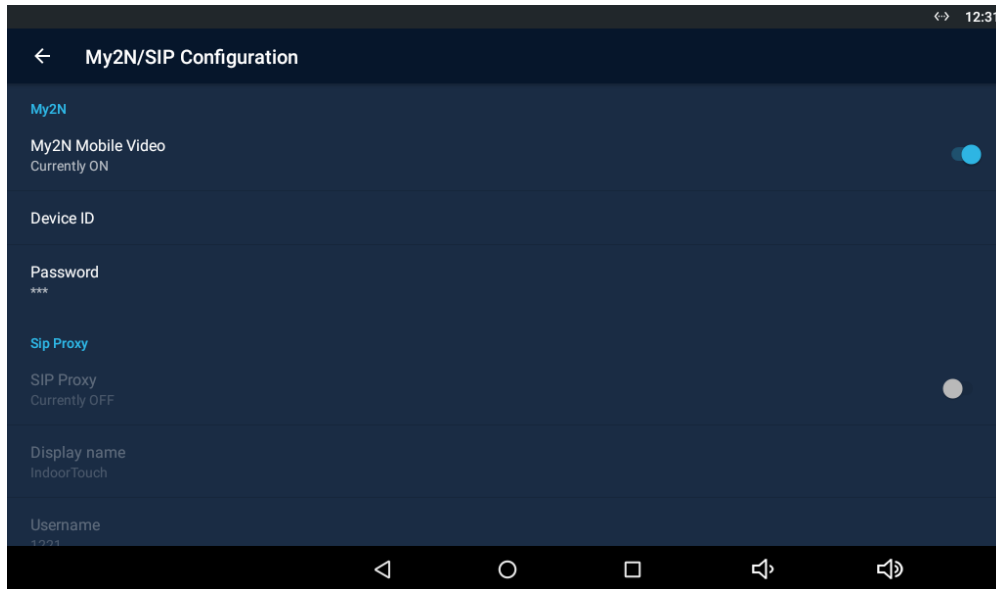

Having completed the login data, press the Log in button for the application to log in and download contacts. Then select a device from the list and make a call.

Refer to faq.2n.cz for how to get login data for the **2N® Mobile Video** servers.

 **Tip**

- Press and hold the lock button to display the lock list (locks 1–4) to control all the locks (not only the default one).
- Click the name of the **2N IP intercom** added using Phonebook via My2N to set up a call with the device immediately. During the call, the microphone on the application side is muted so that the visitor cannot hear you. This mode is suitable for remote silent monitoring of the space in front of the door. This mode is only available to the **2N IP intercoms**. Standard calls can only be made to other applications or the **2N® IndoorTouch** devices.

 **Caution**

- It is impossible to send the DTMF code from the application outside a call for technical reasons. Therefore, if you press the lock outside a call in the SIP Proxy mode, a call is set up first during which the DTMF is sent automatically.
- If the **2N IP intercom** and the application are in one and the same LAN, the incoming call is always identified as a LAN call even if it goes via a SIP Proxy server. If you require SIP Proxy identification and the application and **2N IP intercom** share one and the same LAN, set a different **Access Key** password in the application.
- Earlymedia is always enabled for the My2N mode. This means that the calling door unit video is displayed by the application during ringing.

4.5 Supplementary Information

This subsection provides supplementary information on the **2N® IP Mobile** product.

Here is what you can find in this subsection:

- [4.5.1 Troubleshooting](#)

4.5.1 Troubleshooting

Question: The application cannot see any devices in the LAN mode.

- **Answer:** Check whether your device and the other devices share one and the same LAN. If so, check the settings of the other devices, particularly the **Access Key** password. Make sure that there is a password match for all the listed devices.

Question: The application sees a 2N IP intercom in the LAN but cannot call it.

- **Answer:** Check whether automatic rejection of incoming calls is enabled in the **2N IP intercom**. Find this setting on the device web interface in the Services / Telephone / Calls section. Make sure that automatic receiving of calls on SIP1 line is enabled.

Question: The application video quality is low or video playing is jerky.

- **Answer:** If you are not satisfied with the video quality, set a higher video transmission rate and resolution for your **2N IP intercom**. If your video transmission is jerky or yielding artifacts, your LAN is probably overloaded. Try to earmark a larger bandwidth for VoIP communication on your router or acquire a router that supports the latest Wi-Fi standards (802.11n / 802.11ac). The function may not be ideal with 802.11g.

If your questions still remain unanswered, use the following link please:



Nejčastěji řešené problémy najdete na stránkách faq.2n.cz.

If you are 2N's registered partner or distributor, you can use the Technical Support portal at support.2n.cz.

5. Web Interface Configuration

2N® Indoor Touch allows the user to configure a majority of launcher and **2N® IP Mobile** parameters via the web interface.

Here is what you can find in this section:

- [5.1 Login](#)
- [5.2 System Info](#)
- [5.3 Device](#)
- [5.4 Application](#)
- [5.5 Limitations](#)

5.1 Login

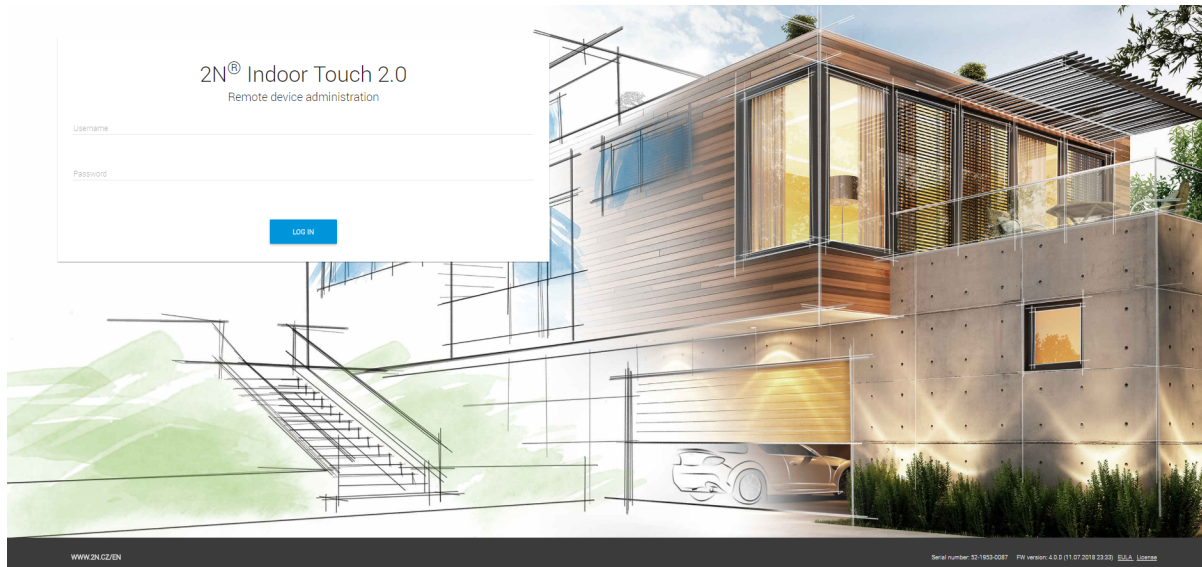

Enter the **2N® Indoor Touch 2.0** IP address into the web browser address row to connect to the web interface. The currently supported browsers are Internet Explorer, Google Chrome, Firefox and Opera.

Then enter the user name and password to access the configuration section. The default values are as follows:

- **User Name:** Admin
- **Password:** 2n (or a valid configuration password in **2N® Indoor Touch 2.0**)

Caution

- An excessively high count of login attempts limits the web interface accessibility for 30 s. After that, it will be possible to relog in.
- If **2N® Indoor Touch 2.0** is allowed to access configuration without a password, then the web interface password is identical with the last-used password and can be changed.

5.2 System Info

This subsection includes relevant system information.

Contents:

- [5.2.1 Status](#)

5.2.1 Status

The Status screen displays a list of basic parameters.

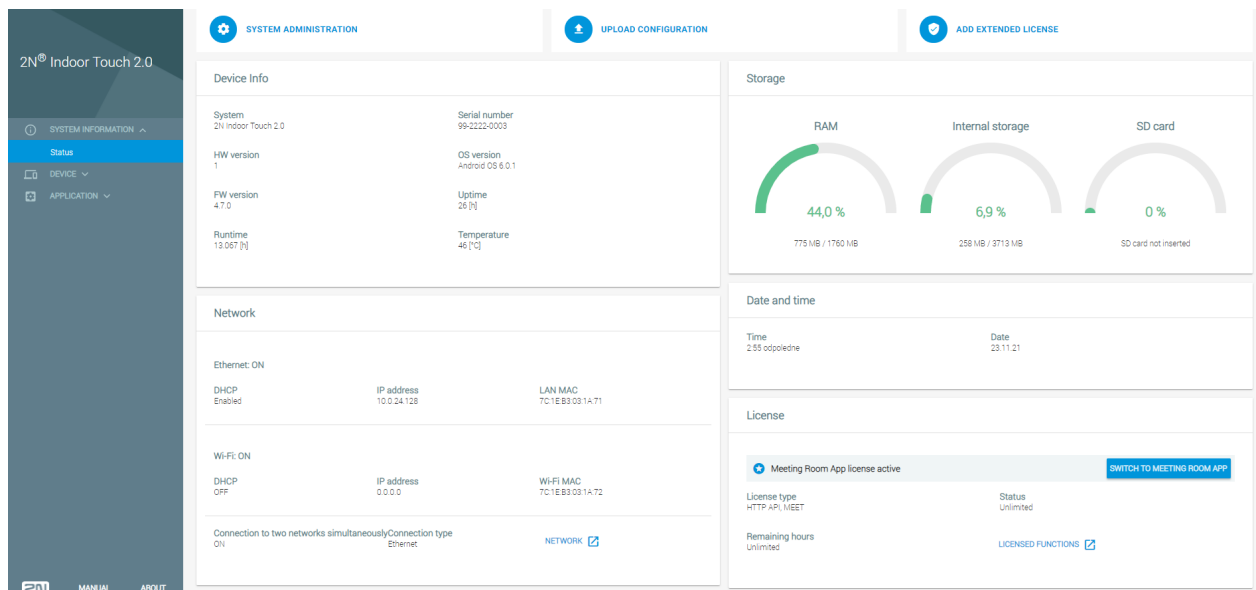

Information on Device

- **System** – device name
- **HW version** – device HW board version
- **FW version** – device firmware version
- **Up time** – total time since the first startup
- **Serial number** – device serial number
- **OS version** – operating system version and type
- **Time since last restart** – time that passed since the last restart
- **Temperature** – current device temperature

Network

- **Ethernet** – *stav ethernetu*
- **DHCP on** – DHCP status
- **IP mask** – IP mask address
- **DNS IP** – DNS IP address
- **Wi-Fi MAC** – Wi-Fi module MAC address
- **IP address** – IP address
- **IP gateway** – IP gateway IP address
- **LAN MAC** – Ethernet module MAC address
- **Wi-Fi support** – Wi-Fi module availability in the device

- **Connection to two networks simultaneously** – informace o stavu připojení
- **Connection type** – primární rozhraní

Storage

- **RAM** – information on the installed, available and used RAM
- **Internal storage** – information on the total and free capacity of the device internal storage
- **SD card** – information on the total and free capacity of the SD card

Date and Time

- **Time** – current time
- **Date** – current date

Licence

- **Licence type** – licence key type
- **Remaining hours** – remaining hours of a time-limited licence, Unlimited for an unlimited licence
- **Status** – Limited / Unlimited / Expired

Licence key types:

- **APP** – allows third party applications to be loaded, this licence is active once the device is purchased.
- **LAUNCHER** – allows **2N® IndoorTouch launcher** to be switched to Android launcher
- **HTTP API** – provides **2N® IndoorTouch** control via API
- **MEET** – allows **2N IndoorTouch launcher** to be switched to the **2N® Meeting Room** application.

 **Caution**

- The original licence key will be overwritten by the new one! Be sure to use a valid licence key obtained from your supplier!

 **Warning**

- The **APP** licence unlocks the option to install user applications from a microSD card (SDHC) in **2N® Indoor Touch 2.0** of up to 16 GB. If, however, any user applications are installed, **2N TELEKOMUNIKACE a.s.** does not guarantee a proper function and stability of such user applications and/or a correct function of the applications pre-installed in **2N® Indoor Touch 2.0**. Should troubles occur, remove the user applications or reset the **device** factory values to get rid of the user applications and settings.

5.3 Device

This subsection describes how to configure the **2N® Indoor Touch** launcher via the web interface.

Contents:

- [5.3.1 Network](#)
- [5.3.2 Home Screen](#)
- [5.3.3 Local Settings](#)
- [5.3.4 Display](#)
- [5.3.5 Audio](#)
- [5.3.6 System Administration](#)

5.3.1 Network

The Network section describes how to configure the Ethernet adapter in **2N® IndoorTouch 2.0**:

LAN

Use Ethernet

Use DHCP

IP address
10.0.24.128

IP mask
255.255.255.0

DNS IP
10.0.100.101

IP gateway
10.0.24.1

CHANGE SETTINGS

- **Use Ethernet** – enable the Ethernet connection
- **Use DHCP** – Yes/No – enable/disable obtaining settings from DHCP
- **IP address** – current IP address
- **IP mask** – IP mask address
- **DNS IP** – DNS IP address
- **IP gateway** – IP gateway IP address
- **Change settings** – display the setting editing window

Network configuration ×

DHCP

IP address *
10.0.24.38

IP mask *
255.255.255.0

IP gateway *
10.0.24.1

DNS IP *
10.0.100.101

CANCEL USE

- **DHCP** – enable/disable obtaining of settings from DHCP. If disabled, the remaining IP address settings become available.
- **IP address** – device IP address
- **IP mask** – IP mask address
- **IP gateway** – IP gateway IP address
- **DNS IP** – DNS IP address

Wi-Fi

Use Wi-Fi

AVAILABLE NETWORKS

STORED NETWORKS

2N Connected	 
TT_Jirka_IPv6_2,4	 
SVPRINT	 
MIKROKOM_EXT	 
test27new	 
TT_Jirka_2,4	 

ADD NETWORK

- **Use Wi-Fi** – enable/disable the Wi-Fi connection. Ethernet and Wi-Fi can be used at the same time. If these two networks are used, select the network for the Internet connection. By turning off Wi-Fi you may execute a system logout. The device may no longer be available at the current address
- **Available networks** – display the list of available Wi-Fi networks.
- **Stored networks** – display the list of stored networks.

Advanced network settings

Connection to two networks simultaneously 
 Status: Enabled
 Connection type
 Wi-Fi

The option to get connected to two different network interfaces at the same time enables the product to be operated in two different network environments simultaneously. Thus, for example, you can communicate with the 2N intercoms in one network via Ethernet and control home automation in another network via Wi-Fi. Remember to define the network to be used for Internet connection if two networks are connected simultaneously.

- **Connection to two networks simultaneously** – display the Ethernet + Wi-Fi connection state.
- **Connection type** – display and edit the Internet connecting network.

Caution

- Where two networks are used simultaneously (Ethernet + Wi-Fi), packets are not routed from one network to another. It is because **2N® Indoor Touch 2.0** is just a client and not a network element in either network.

5.3.2 Home Screen

The Home Screen tab helps you set positions for applications and their icons and includes the list of all available applications in the system.

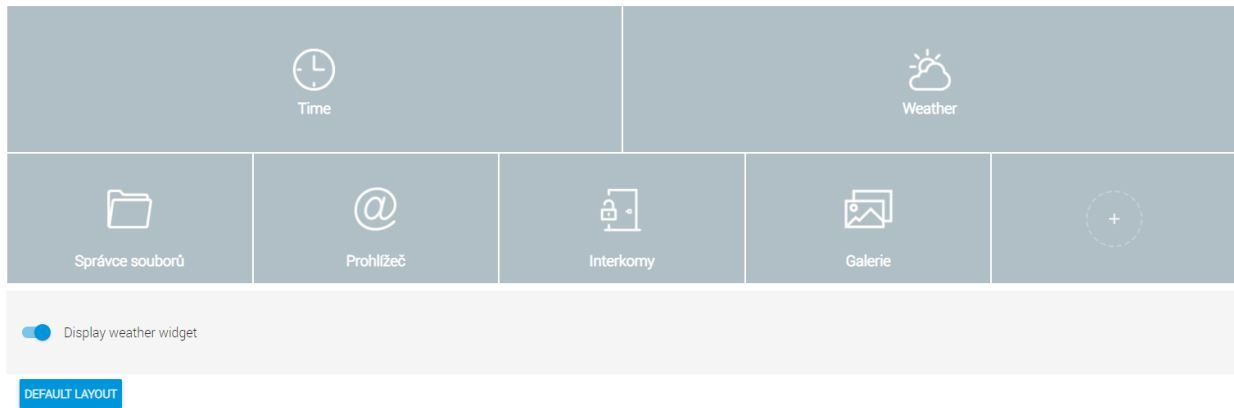

- **Display weather widget** – display the current weather information.
- **Default layout** – reset the default application icon layout on the home screen.

Application

USED APPLICATIONS		MORE APPLICATIONS	
Application ↑	Name	Installation date	Version
2N® IP Mobile	Intercoms	11.07.2018	4.4.3 (414)
File Manager	File Manager	12.07.2018	2.1.2 (212)
Galerie	Gallery	12.07.2018	1.1.40030 (40030)
Prohlížeč	Browser	12.07.2018	4.4.2-20180712 (19)

Application

- **Used applications** – display the list of used applications on the home screen.
- **More applications** – display the list of all applications available in the device.















Click a position to display a position setting window:

Add application to position 5 ×

Name

Application*



Icon Change icon















Default icon

CANCEL ADD

- **Name** – application name to be displayed at the given position
- **Application** – display the list of applications installed in the device. Select an application to set the home screen position for launch.
- **Icon** – select the application icon.
- **Change icon** – replace the icon with another one or the default one.

Caution

- For security reasons, it is impossible to remove the setting  and information  icons from the Home Screen. All you can do is create their duplicates on other positions and then remove the icons from their original positions.

5.3.3 Local Settings

The tab helps you change the language, time zone and weather settings.

- **Basic settings**

- **Device name** – user device ID. Shown in 2N® Network Scanner and 2N® IP Eye in the lists of LAN devices visible to other 2N devices.
- **Language** – change the language for most of the applications (Gallery, etc.). English is used by default.

- **Date and time** – select the date, time and time zone.

- **Time zone** – select the time zone. GMT + 00:00 is used by default.
- **Use time from LAN** – use network time or set time manually.
- **Currently displayed date and time** – date and time currently displayed on the home screen.
- **Date display format** – select the date display format.
- **Use 24-hour format** – select either 12-hour or 24-hour format.

- **Weather** – change the weather settings.

- **Location** – location for the weather forecast. Keep the OpenWeatherMap.org format.
- **Save** – save the set location.
- **Update** – set the weather data refreshment rate: 1 hour or 2 hours.
- **Units** – temperature units: Metric (°C) or Imperial (°F).

- **Source** – open the data source: OpenWeatherMap.org.

5.3.4 Display

The Display tab helps you change the display turn-off and brightness as well as LED notifications.

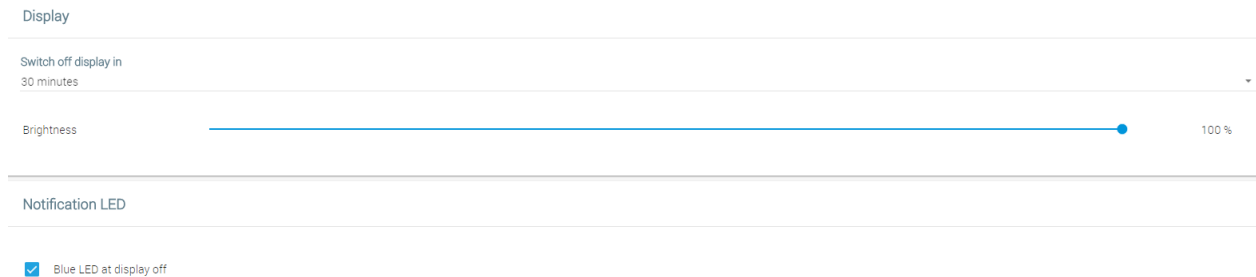

- **Display** – display settings
 - **Switch off display in** – turn off the display in 1 to 30 minutes
 - **Brightness** – set the display brightness: 10–100 %
- **Notification LED** – set the LED notifications
 - **Blue LED at display off** – when the display turns off, the blue LED goes on. This setting helps you identify whether your display or the device is off.

5.3.5 Audio

This tab helps you set the volume of ringing, notifications, applications and others.

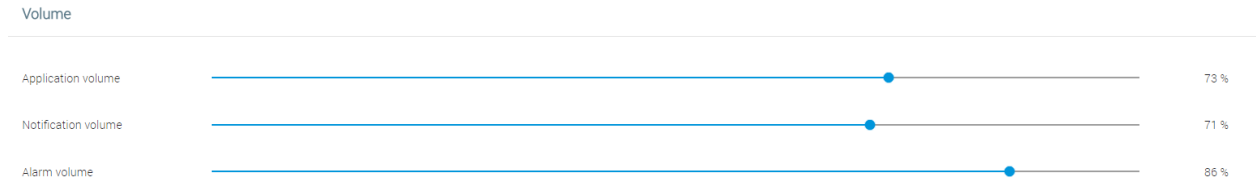

- **Application volume** – set the music, video, game and audio volumes: 0–100 %.
- **Notification volume** – set the ringing and notification volumes: 0–100 %.
- **Alarm volume** – set the alarm clock volume: 0–100 %.

5.3.6 System Administration

The System Administration tab helps you upgrade firmware, back up/upload configuration and change the password.

System administration

Enable service mode

- **System administration**
 - **Enable service mode** – enable access to the device for servicing purposes.



- **Restart device** – confirm and perform the device restart.
- **Factory reset** – confirm and perform the factory reset.
- **Firmware upgrade** – upload a new firmware version and restart + upgrade:

Device FW upgrade



Select file

FW status
Please select upgrade file

Current version
4.0.0

CANCEL UPGRADE

- **Select file – Select** – select the .img firmware file.
- **FW status** – display the firmware upload status.
- **Current version** – display the current firmware version.

Configuration



DOWNLOAD CONFIGURATION



UPLOAD CONFIGURATION

Configuration

- **Download Configuration** – download the current configuration into a PC.
- **Upload Configuration** – upload configuration from a PC file to the device. Click to display a window to select whether the whole configuration is to be uploaded or the part containing IP addresses should be omitted.

Password

Use separate web access password

WEB ACCESS PASSWORD

ADMINISTRATOR PASSWORD

SETTING PASSWORD

Password

- **Use separate web access password** – set a separate access password for the device web interface.
- **Web Access Password** – set a web interface access password. Make sure that it contains eight characters at least including one capital letter, one small letter and one digit.
- **Administrator Password** – set an administrator setting access password.
- **Setting Password** – set a device setting access password.

Screen security

Screen lock

Screen security

- **Screen lock** – display the current screen security details. Activate the function on the device display only.

Logs

Select the log type to download.

Basic logs 

All logs

DOWNLOAD

Logs

- **Select the log type to download**
 - **Basic logs** – basic system information (dmesg, logcat, 2N_info, getprop).
 - **All logs** – complete logs for troubleshooting purposes. All available logs will be downloaded.

Network trace

Current status ERROR

Buffer size 20480 kB

Buffer usage 0 kB

 RESET

 START

 DOWNLOAD

Network trace

If **2N® Indoor Touch 2.0** communicates with a 2N IP intercom or a third-party device, the network trace can be a very useful diagnostic and troubleshooting tool should the communication fail.

 **Tip**

- Refer to the FAQ section for how to download the network trace and logs from **2N® Indoor Touch 2.0**.

5.4 Application

This subsection describes how to change the **2N® IP Mobile** configuration via a web interface.

Contents:

- [5.4.1 Intercoms](#)
- [5.4.2 Settings](#)

5.4.1 Intercoms

The Intercoms tab helps you display the devices added to **2N® IP Mobile** and new LANs and SIP Proxy devices.

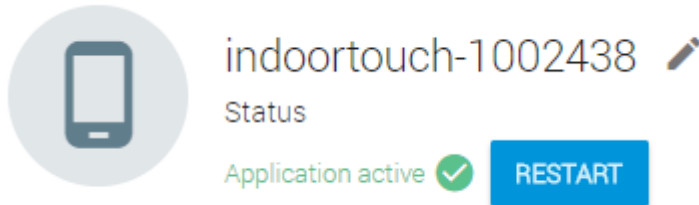

indoortouch-1002438 

Status

Application active  **RESTART**

 sets the device ID to be displayed in the LAN device list in all the 2N devices in one and the same LAN. You can direct a call to this device by setting the user phone number as device:device_ID in these devices.

- **Restart** – restart the **2N® IP Mobile** application.
- The pencil icon helps you edit the device ID.

Device ID setting ×

Device ID *

2NIndoorTouch-5221010046

 Set the device ID to be displayed in the LAN device list in all the 2N devices in one and the same LAN. You can direct a call to this device by setting the user phone number as device:device_ID in these devices.

CANCEL USE

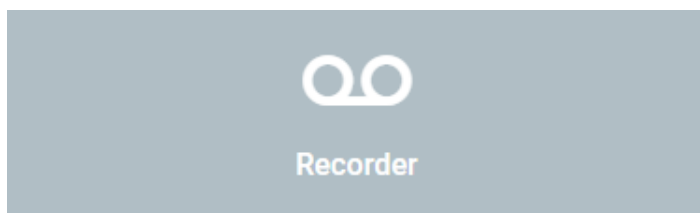

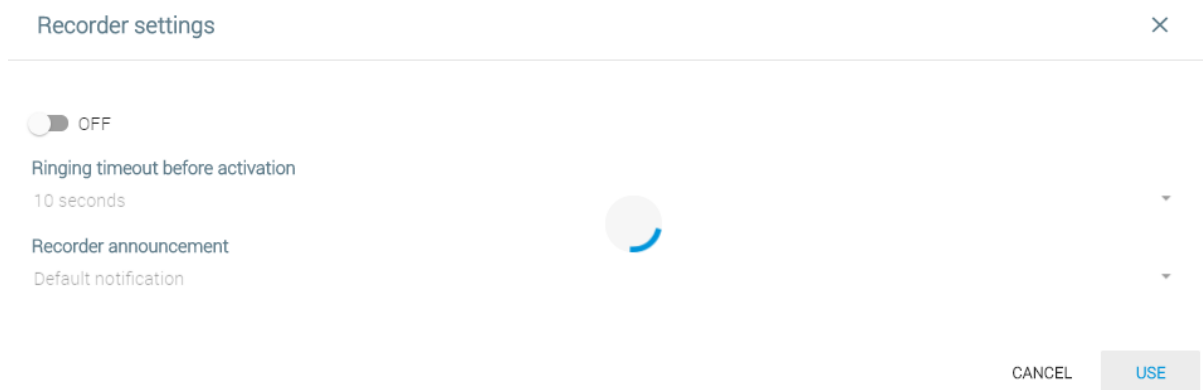

Recorder Settings

- **ON/OFF** – enable/disable the recorder function.
- **Ringing timeout before activation** – set the recorder activation timeout: 10 to 30 seconds.
- **Recorder announcement** – select the recorder announcement. Cannot be set via the web.

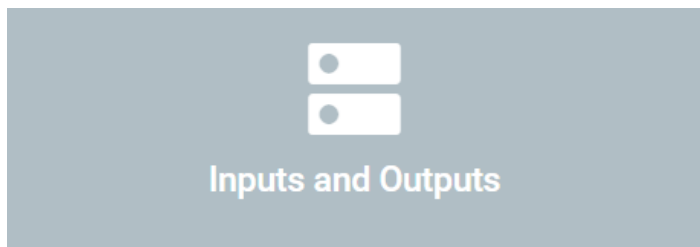

Input and output settings
×

Doorbell ringtone
Flutey Phone ▼

Ignore DND setting for inputs
 OFF

Ignore DND setting for outputs
 OFF

Application reacts to the following inputs

Input 1

Input 2

The application uses the following outputs

Output 1

Incoming call notification

Activation option at incoming call

Select input ▼

Output 2

CANCEL USE

Input and output settings

- **Doorbell ringtone** – choose the default user doorbell ringtone. The tone length is set to 10 s at doorbell activation.
- **Ignore DND setting for inputs** – allow this parameter to ignore the DND mode at input activation.
- **Ignore DND setting for outputs** – allow this parameter to ignore the DND mode at output activation.
- **Application reacts to the following inputs** – select the input to be used, both the inputs can be used simultaneously.
- **Input 1, 2** – activate the doorbell button input.
- **The application uses the following outputs** – select the output to be used, both the outputs can be used simultaneously.
 - **Output 1, 2** – activate the relay output. One output can be connected to 1 input or 2 inputs at the same time.

- **Incoming call notification** – when the doorbell button is pressed, a notification is displayed on the device and acoustic signaling is activated.
- **Activation option at incoming call** – when the doorbell button is pressed, a notification is displayed on the device, acoustic signaling is activated and the remote control option becomes available for input 1 / 2 lock activation as set for the user.
 - **Input 1, 2** – connect the input to the given output.

 **Tip**

- Make sure that the wiring diagram shown on the device motherboard is kept to make the system work properly. Refer to Subs. [2.1 Before You Start](#) for motherboard details.

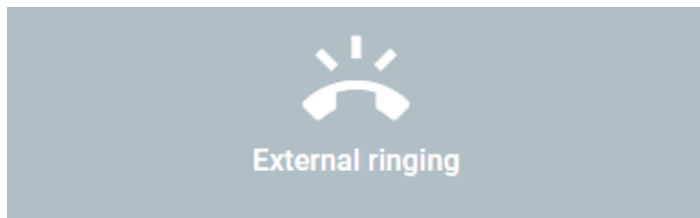

External ringing setting ×

OFF

Invert relay output

Ignore DND setting

Used output

Relay 1

Relay 2

Minimum relay activation time (seconds) *

3

Maximum relay activation time (seconds) *

30

CANCEL USE

External ringing settings

- **ON/OFF** – enable/disable the external ringing function.

- **Invert relay output** – set the input response to the pulse rise/fall time.
- **Ignore DND setting** – indicate an incoming call by an output in the DND mode.
- **Used output** – select the hardware output.
- **Minimum relay activation time (seconds)** – set the minimum relay activation time in which the external ringing is automatically terminated.
- **Maximum relay activation time (seconds)** – set the maximum relay activation time in which the external ringing is automatically terminated.

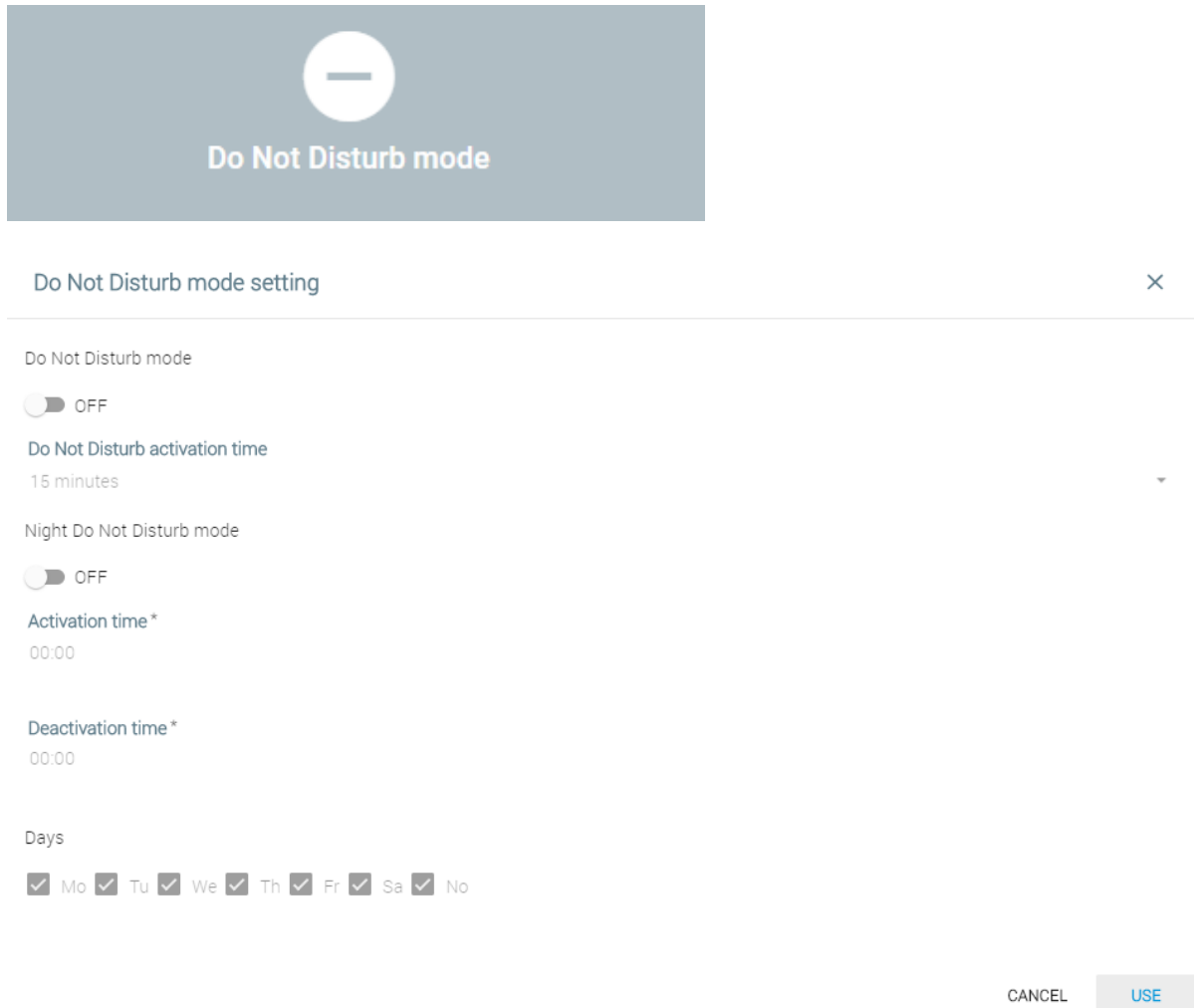

The image shows a mobile application interface for setting 'Do Not Disturb' mode. At the top, there is a grey header with a white circle containing a minus sign and the text 'Do Not Disturb mode'. Below this is a title bar 'Do Not Disturb mode setting' with a close button (X) on the right. The main content area includes:

- 'Do Not Disturb mode' with a toggle switch set to 'OFF'.
- 'Do Not Disturb activation time' set to '15 minutes' with a dropdown arrow.
- 'Night Do Not Disturb mode' with a toggle switch set to 'OFF'.
- 'Activation time*' set to '00:00'.
- 'Deactivation time*' set to '00:00'.
- 'Days' with checkboxes for Mo, Tu, We, Th, Fr, Sa, and No, all of which are checked.

 At the bottom right, there are two buttons: 'CANCEL' and 'USE'.

Do Not Disturb mode setting

- **Do Not Disturb mode** – activate the one-time DND mode.
- **Do Not Disturb activation time** – set a time interval in which the DND mode is active: from 15 minutes to 24 hours or permanently.
- **Night Do Not Disturb mode** – activate the night DND mode.
- **Activation time** – set the exact night DND activation time.
- **Deactivation time** – set the exact night DND deactivation time.
- **Days** – select the weekdays on which the night DND mode is to be active.



My2N settings ×

OFF

Device ID *

Password *

CANCEL USE

My2N settings

- **ON/OFF** – enable/disable the My2N connection.
- **Device ID** – set the device ID.
- **Password** – set the My2N login password.

Info

- Refer to faq.2n.cz for a separate **2N® Mobile Video** document, where you can find how to obtain data for login to the service servers.



SIP Proxy settings
×

OFF

Displayed name*
IndoorTouch

Username
111

Password

SIP Proxy address

Port*
5060

SIP port randomization

Port*
5060

Transport protocol

UDP

TCP

SIP Registrar

OFF

Address

Port*
5060

Registration Expiry*
120

CANCEL USE

SIP Proxy settings – set the data necessary for the SIP Proxy server connection.

- **ON/OFF** – enable/disable the SIP Proxy connection and set the details.
- **Displayed name** – set the device/ **2N® IP Mobile** name to be displayed for the SIP Proxy purposes.
 - **Username** – user name/number as registered with the SIP Proxy server.
 - **Password** – password of the user registered with the SIP Proxy server.
 - **SIP Proxy address** – SIP Proxy server IP address
 - **Port** – select the port for the SIP Proxy server to listen on. Default value: port 5060. Range: 1–65535.
 - **SIP port randomization** – set the SIP port randomization.
 - **Transport protocol** – select the transport protocol.
 - **SIP Registrar** – enable device registration with the set SIP Registrar.
 - **Address** – set the SIP Registrar IP address or domain name.
 - **Port** – set the SIP Registrar port (typically 5060).

- **Registration Expiry** – set the registration expiry, which affects the network and SIP Registrar load by periodically sent registration requests. The SIP Registrar can alter the value without letting you know.

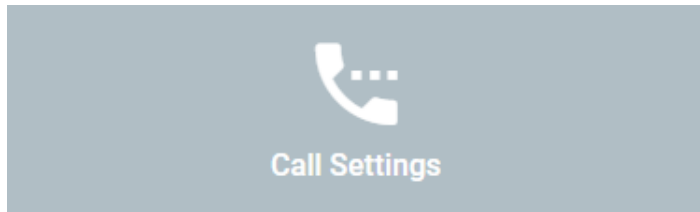

Call Settings
×

Automatic call pickup

Video display before call pickup

Automatic call pickup delay

0 seconds ▼

Call ringtone

Flutey Phone ▼

CANCEL
USE

Call settings

- **Automatic call pickup** – activate automatic call answering.
- **Video display before call pickup** – enable video preview before call pick up.
- **Automatic call pickup delay** – set the automatic call pickup timeout: from 0 to 30 s.
- **Call ringtone** – set the incoming call ringtone.

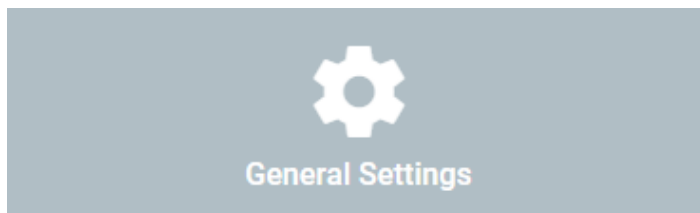

Application settings
×

- Automatic call screenshot
- Push to talk
- Logging
- Multicast Discovery
- Custom language localization

Local video preview

- Unicast
- Multicast

Automatic preview deactivation

2 minutes ▾

Set configuration access password

Set IP intercom group password

CANCEL USE

Application settings

- **Automatic call screenshot** – enable automatic call screenshots.
- **Push to talk** – enable Push to talk.
- **Logging** – enable/disable extended logging.
- **Multicast Discovery** – set the background communication between the 2N devices.
- **Custom language localization** – activate custom localization for **2N® IP Mobile**.
- **Local video preview** – set Unicast or Multicast video transmission.
- **Automatic preview deactivation** – set the time in which the video transmission is deactivated: 1–30 minut.
- **Set configuration access password** – set the configuration access password.
- **Set IP intercom group password** – set the IP intercom group password.

⚠ Caution

- The configuration access and IP intercom group passwords can contain 0–64 characters. The minimum password length is not set. All characters are allowed.

Device

ADDED DEVICES	LAN	SIP
Device name		
2N IP Verso		

- **Added devices** – list of added devices.
- **LAN** – available LAN devices including the adding and editing options.
- **SIP** – list of manually created SIP contacts including the adding and editing options.

Edit device
×

Device name *
2N IP Verso

Lift

Unlock button 1 ON	<input checked="" type="checkbox"/>	<input type="checkbox"/>
Unlock button 2 ON	<input checked="" type="checkbox"/>	<input type="checkbox"/>
Unlock button 3 ON	<input checked="" type="checkbox"/>	<input type="checkbox"/>
Unlock button 4 ON	<input checked="" type="checkbox"/>	<input type="checkbox"/>

CANCEL
USE

Edit device

- **Device name** – device name with the editing option.
- **Unlock button 1-4** – define the button(s) to be displayed.
 - **Lift** – select this option to display the selected button only during the call as a lift icon.

✓ Tip

- Refer to [here](#) for the intercom settings to ensure the proper functionality.

5.4.2 Settings

This tab helps you set other functions related to applications.

Settings

Enable application installation

Return to application after call end

Logging

Allow notifications

Launch application on startup
None

Open URL on startup USE

- **Enable application installation** – enable installation of third party applications.
- **Return to application after call end** – set this option to move **2N® IP Mobile** to the background again after an incoming call is ended.
- **Logging** – enable/disable application logging to the system log.
- **Allow notifications** – allow applications to control notifications.
- **Launch application on startup** – enter an application name (*com.android.browser, e.g.*) to launch this application upon startup.
- **Open URL on startup** – enter the URL address to launch a web browser and move to the set address upon startup.

Caution

- The application and URL are mutually exclusive upon startup.

5.5 Limitations

The web interface is always available to 1 user at a time. This applies to more tabs on 1 PC too. Therefore, remember to log in to each tab every time.

Caution

- Once a new user logs in to the web interface, the previous user will be logged out automatically.

7. Technical Parameters

Power Supply

- **Type:** external power adapter part no. 91378381E, 91378381GB, 91378381US (SELV type with LPS) 90–230 V, 50–60 Hz to 12 V DC 0,75 A or Power over Ethernet (PoE 802.3af)

Power Consumption

- **In idle:**
 - **12 V:** 2,64 W – 0.22 A
 - **PoE:** 3,6 W
- **Max. in active state:** 12 W / 1 A

User Interface

- **Control:** capacitive touch panel
- **Display size:** 7"
- **Resolution:** 1024 x 600 px
- **Backlight:** LED
- **Status indicator:** 1 RGB LED

Audio

- **Microphone:** integrated
- **Loudspeaker:** 2 W integrated

OS

- **Android 6.0.1**

Interface

- **LAN:** 10/100BaseT, RJ-45; Cat5e or higher (recommended)
- **Memory card:** microSD card (SDHC) up to 16GB
- **WiFi:** 802.11b/g/n, integrated antenna (not available in Korea, Japan and Malaysia)

Wi-Fi Module

- **Supported authentication methods:**
 - WEP, WPA/WPA2 PSK and 802.1x EAP

Mechanical Parameters

- **Dimensions (w x h x d):** 235 x 165 x 40 mm
- **Weight:** 850 g
- **Operating temperature:** 0°C – 60°C
- **Relative humidity:** 10% – 90% (non-condensing)
- **Storing temperature:** –20 °C – 70 °C
- **Recommended altitude:** 0–2000 m

I/O Description

- **HW v4**

Signification	Name	Restriction
ANALOG IN 1/2	Analog Input	0–5 V DC 1.5 M Ω
OUTPUT 1/2	Digital Output	Voh = 3.3 V DC 0.33 mA
INPUT 1/2	Digital Input	Vihmax = 5 V DC 100 k Ω
IN (OUT) 1/2	Digital Input/Output	Vihmax = 3.3 V DC (100 Ω serial resistor), Voh = 3.3 V DC 4 mA (100 Ω serial resistor)
REL1/2	Relay	contact data: max 30 V DC 1 A. DC 12 V +/- IN = power input: Vinmax = 12 V DC I _{max} = 1 A. DC 12 V + OUT = power output: Vout = 12 V DC I _{max} = 100 mA
DC12V+ OUT	+12 V output	I _{max} = 100 mA
DC12V+ IN	+12 V input	I _{min} = 1000 mA
GND	Ground (–12 V input)	

7.1 General drawings

Surface mounting

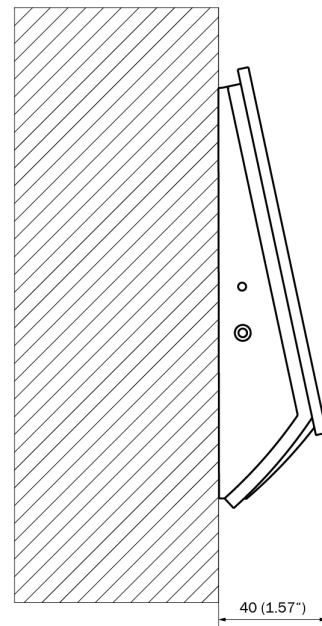
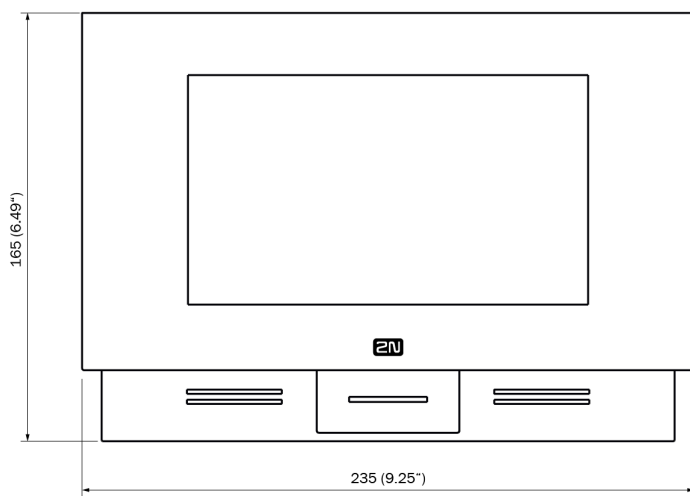

8. Supplementary Information

This section provides supplementary information on the **2N® Indoor Touch 2.0** product.

Here is what you can find in this section:

- [8.1 Troubleshooting](#)
- [8.2 Directives, Laws and Regulations - General Instructions and Cautions](#)
- [8.3 Other Countries' Legislation](#)

8.1 Troubleshooting

Trouble: The device always switches off the display before timeout.

- **Advice:** Check the device temperature. If improperly installed, **2N® Indoor Touch 2.0** automatically turns into the stand-by mode to reduce the device temperature if critical to avoid forced turn-off / reset in extreme cases. The user is notified of this problem by a short display of the notification window. Display the current device temperature in the Setting section.

Trouble: The device does not start and remains in one of the LED states or gets restarted round and round.

- **Advice:** Press and hold the Reset button on the device backside during the startup to restore the factory values automatically. If the trouble persists, upgrade the system via an SD card. If the trouble still persists, contact the Servicing centre.

Trouble: The device fails to emit sounds, even the incoming call ringing.

- **Advice:** Check the volume setting and adjust the loudspeaker volume level if necessary with the Volume up/down buttons on the lower status bar.



For the most frequently asked questions refer to faq.2n.cz.

8.2 Directives, Laws and Regulations - General Instructions and Cautions

2N® Indoor Touch 2.0 conforms to the following directives and regulations:

- 2014/53/EU for radio equipment
- 2011/65/EU on the restriction of the use of certain hazardous substances in electrical and electronic equipment
- 2012/19/EU on waste electrical and electronic equipment

Industry Canada

This Class B digital apparatus complies with Canadian ICES-003/NMB-003.

FCC

This equipment has been tested and found to comply with the limits for a Class B digital device, pursuant to part 15 of the FCC Rules.

NOTE: These limits are designed to provide reasonable protection against harmful interference in a residential installation. This equipment generates, uses and can radiate radio frequency energy and, if not installed and used in accordance with the instructions, may cause harmful interference to radio communications.

However, there is no guarantee that interference will not occur in a particular installation. If this equipment does cause harmful interference to radio or television reception, which can be determined by turning the equipment off and on, the user is encouraged to try to correct the interference by one or more of the following measures:

- Reorient or relocate the receiving antenna
- Increase the separation between the equipment and receiver
- Connect the equipment into an outlet on a circuit different from that to which the receiver is connected
- Consult the dealer or an experienced radio/TV technician for help

Changes or modifications to this unit not expressly approved by the party responsible for compliance could void the user's authority to operate this equipment.

Please read this User Manual carefully before using the product. Follow all instructions and recommendations included herein.

Any use of the product that is in contradiction with the instructions provided herein may result in malfunction, damage or destruction of the product.

The manufacturer shall not be liable and responsible for any damage incurred as a result of a use of the product other than that included herein, namely undue application and disobedience of the recommendations and warnings in contradiction herewith.

Any use or connection of the product other than those included herein shall be considered undue and the manufacturer shall not be liable for any consequences arisen as a result of such misconduct.

Moreover, the manufacturer shall not be liable for any damage or destruction of the product incurred as a result of misplacement, incompetent installation and/or undue operation and use of the product in contradiction herewith.

The manufacturer assumes no responsibility for any malfunction, damage or destruction of the product caused by incompetent replacement of parts or due to the use of reproduction parts or components.

The manufacturer shall not be liable and responsible for any loss or damage incurred as a result of a natural disaster or any other unfavourable natural condition.

The manufacturer shall not be held liable for any damage of the product arising during the shipping thereof.

The manufacturer shall not make any warrant with regard to data loss or damage.

The manufacturer shall not be liable and responsible for any direct or indirect damage incurred as a result of a use of the product in contradiction herewith or a failure of the product due to a use in contradiction herewith.

All applicable legal regulations concerning the product installation and use as well as provisions of technical standards on electric installations have to be obeyed. The manufacturer shall not be liable and responsible for damage or destruction of the product or damage incurred by the consumer in case the product is used and handled contrary to the said regulations and provisions.

The consumer shall, at its own expense, obtain software protection of the product. The manufacturer shall not be held liable and responsible for any damage incurred as a result of the use of deficient or substandard security software.

The consumer shall, without delay, change the access password for the product after installation. The manufacturer shall not be held liable or responsible for any damage incurred by the consumer in connection with the use of the original password.

The manufacturer also assumes no responsibility for additional costs incurred by the consumer as a result of making calls using a line with an increased tariff.

Electric Waste and Used Battery Pack Handling



Do not place used electric devices and battery packs into municipal waste containers. An undue disposal thereof might impair the environment!

Deliver your expired electric appliances and battery packs removed from them to dedicated dumpsites or containers or give them back to the dealer or manufacturer for environmental-friendly disposal. The dealer or manufacturer shall take the product back free of charge and without requiring another purchase. Make sure that the devices to be disposed of are complete.

Do not throw battery packs into fire. Battery packs may not be taken into parts or short-circuited either.

8.3 Other Countries' Legislation

Thailand

เครื่องโทรคมนาคมและอุปกรณ์นี้มีความสอดคล้องตามมาตรฐานหรือข้อกำหนดทางเทคนิคของ กสทช.



เครื่องวิทยุคมนาคมนี้ได้รับยกเว้น ไม่ต้องได้รับใบอนุญาตให้มี ใช้ซึ่งเครื่องวิทยุคมนาคมหรือตั้งสถานีวิทยุคมนาคมตามประกาศ กสทช. เรื่อง เครื่องวิทยุคมนาคม และสถานีวิทยุคมนาคมที่ได้รับยกเว้นไม่ต้องได้รับใบอนุญาตวิทยุคมนาคมตามพระราชบัญญัติวิทยุคมนาคม พ.ศ. 2498



nans. | โทรคมนาคม

กำกับดูแลเพื่อประชาชน

Call Center 1200 (InSW5)

6. Maintenance - Cleaning

If used frequently, the device surface gets dirty. Use a piece of soft cloth moistened with clean water to clean the device.

You are recommended to follow the principles below while cleaning:

Do not use aggressive detergents (such as abrasives or strong disinfectants). Use appropriate cleaning agents suitable for glasses, optical devices, screens, etc. Alcohol-based cleaners may not be applied. We recommend you to use IT cleaning wipes.

