

Installation manual 2N[®] IP Audio Kit



Content:

- 1. Product Overview
 - 1.1 Components and Associated Products
 - 1.2 Terms and Symbols
- 2. Description and Installation
 - 2.1 Before You Start
 - 2.2 Mechanical Installation
 - 2.3 Electric Installation
 - 2.3.1 Overvoltage Protection
 - 2.4 Extending Module Connection
 - 2.5 Configuration
 - 2.6 Downloads
- 3. Technical Parameters
- 4. Supplementary Information
 - 4.1 Troubleshooting
 - 4.2 Directives, Laws and Regulations
 - 4.3 General Instructions and Cautions

1. Product Overview

Here is what you can find in this section:

- [1.1 Components and Associated Products](#)
- [1.2 Terms and Symbols](#)

Basic Features

2N® IP Audio Kit is a universal and reliable IP intercom module designed for integration in the third parties' equipment. It is provided with a number of useful functions that are not quite common in the devices of this category. Featuring the SIP standard support and compatibility with renowned IP exchange and telephone manufacturers, **2N® IP Audio Kit** can make use of all VoIP services available on the market.

2N® IP Audio Kit is equipped with a 10 W power amplifier for external loudspeaker connection. If the power output of amplifier is insufficient for your specific application, you can connect an external power amplifier to the line output. You can also connect an external electret microphone or another audio signal source to the IP intercom line output.

2N® IP Audio Kit allows up to 16 separate buttons or a 16-button matrix keypad to be connected. Set the button function flexibly according to your specific application needs. You can set up to three telephone numbers and call time profiles to each of the buttons to make the called subscriber accessible any time. Configure the buttons as a numerical keypad, which can be used as a switch activation code lock or for dialling a preset or any other telephone number.

2N® IP Audio Kit is equipped with one relay output and two active 12V outputs. Use the numerical keypad or, during the call, any telephone to control these outputs. A wide range of output mode settings help you make use of a high number of applications.

2N® IP Audio Kit is equipped with two galvanically isolated digital inputs and three status signalling outputs.

2N® IP Audio Kit is very easy to install. All you have to do is connect it to your LAN using the LAN cable. An integrated two-port LAN switch simplifies installation on sites with a limited LAN infrastructure. Supply the intercom either from a 9–36V source or directly from your PoE supporting LAN.

Use a PC web browser to configure your **2N® IP Audio Kit**. Apply the **2N® Access Commander** to administer extensive intercom installations easily and quickly.



Advantages of Use

- Industrial design and variable mounting options
- Wide supply power range + PoE supply
- Integrated 10 W power amplifier
- External amplifier connection
- External microphone/audio signal source connection
- Galvanically isolated relay output
- Two controlled active 12 V outputs
- Two galvanically isolated logic inputs
- Up to 3 signalling LED outputs
- Up to 16 external buttons/matrix keypad connection
- Integrated two-port LAN switch
- Bidirectional communication – acoustic echo cancelling
- Configuration via web interface/special PC application
- SIP 2.0 support
- HTTP(S) server for configuration
- SNTP client for server time synchronisation
- RTSP server for audio streaming
- TFTP client for automatic configuration and firmware update

1.1 Components and Associated Products

Basic Units

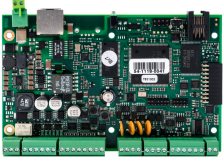
<p>2N Part No. 9154100</p> <p>Axis Part No. 01526-001</p>  <p>The image shows a rectangular, light-colored intercom module. The top surface has a green Ethernet port on the left and two RJ45 ports on the right. The front panel features the 'audioKIT' logo with '2N IP' above it. Below the logo, there are several rows of small, green-labeled ports and indicators, including labels for 'RELAY', 'LINE', 'SPEAKER', 'MICROPHONE', 'LINE', 'RELAY', and 'STATUS'.</p>	<ul style="list-style-type: none">• Intercom module in plastic box
-------------------------------------------------------------------------------------------------------------------------------------------------------------------------------------------------------------------------------------------------------------------------------------------------------------------------------------------------------------------------------------------------------------------------------------------------------------------------------------------------------------------------------------------------------------------------------------------	----------------------------------------------------------------------------------

<p>Part No. 9154101</p> 	<ul style="list-style-type: none"> • Intercom module without box
<p>Part No. 9154102</p> 	<ul style="list-style-type: none"> • Lite intercom module in plastic box

2N Internal Units and Accessories

<p>Part numbers:</p> <p>2N Part No. 91378375</p> <p>Axis Part No. 01668-001</p> <p>2N Part No. 91378376</p> <p>Axis Part No. 01670-001</p> 	<ul style="list-style-type: none"> • 2N® Indoor Touch 2.0 – black • WiFi (second Part no.) • The elegant internal touch panel, 2N® Indoor Touch 2.0, is suitable for all 2N IP intercoms. On the panel's display not only can you find out who is at the door, but also start a conversation with the visitor, open the lock or turn on the light in the entrance hall.
-------------------------------------------------------------------------------------------------------------------------------------------------------------------------------------------------------------------------------------------------------------------	-------------------------------------------------------------------------------------------------------------------------------------------------------------------------------------------------------------------------------------------------------------------------------------------------------------------------------------------------------------------------------------------------------------------------------

2N Part No. 91378382

Axis Part No. 01425-001



- **2N® Indoor Touch** desk stand black

Part numbers:

2N Part No. 91378375WH

Axis Part No. 01669-001

2N Part No. 91378376WH

Axis Part No. 01671-001



- **2N® Indoor Touch 2.0** – white
- WiFi (second Part no.)
- The elegant internal touch panel, **2N® Indoor Touch 2.0**, is suitable for all **2N IP intercoms**. On the panel's display not only can you find out who is at the door, but also start a conversation with the visitor, open the lock or turn on the light in the entrance hall.

2N Part No. 91378382W

Axis Part No. 01426-001



- **2N® Indoor Touch** desk stand white

**2N Part No.
1120101W**

**Axis Part No.
02518-001**



- **2N® IP Handset**
- answering unit
- white color

**2N Part No.
1120101B**

**Axis Part No.
02519-001**



- **2N® IP Handset**
- answering unit
- black color

IP Telephones

2N Part No. 91378360
Axis Part No. 01586-001



- **Yealink SIP T58A IP video phone**
- simple operation
- HD quality video calls
- A display-equipped extender EXP50 (Part No. **91378363**) can be added to the phone delivery to make up to 60 speed dialings.

2N Part No. 1120111EU
Axis Part No. 02544-001



- **Grandstream GXV3350 IP video phone**
- Android 7.0 OS
- 5" touch display control
- HD quality video calls
- WiFi and Bluetooth support
- HDMI output and pan tilt zoom camera
- Easy integration with intercoms or PBXs via SIP

2N Part No. 91378362EU





- **Grandstream GXV3370 IP video phone**
- Android 7.0 OS
- 7" touch display control
- HD quality video calls
- WiFi and Bluetooth support
- Easy integration with IP intercoms, PBXs and security cameras.



Electric Locks



<p>obj. č. 11202101</p> 	<ul style="list-style-type: none"> • Mini electronic doorstrike series 5 • electric opener designed for door frame installation • intended for such narrow profiles as aluminum, wood or PVC in particular • short sheet metal front cover version (130 mm) • 16 mm width
<p>obj. č. 11202101-L</p> 	<ul style="list-style-type: none"> • Mini electronic doorstrike series 5, long • electric opener designed for door frame installation • intended for such narrow profiles as aluminum, wood or PVC in particular • long sheet metal front cover version (250 mm) • 16 mm width
<p>obj. č. 11202102</p> 	<ul style="list-style-type: none"> • Mini electronic doorstrike series 5 - with momentum pin • electric opener designed for door frame installation • intended for such narrow profiles as aluminum, wood or PVC in particular • short sheet metal front cover version (130 mm) • 16 mm width

<p>obj. č. 11202102-L</p> 	<ul style="list-style-type: none"> • Mini electronic doorstrike series 5 - with momentum pin, long • electric opener designed for door frame installation • intended for such narrow profiles as aluminum, wood or PVC in particular • long sheet metal front cover version (250 mm) • 16 mm width
<p>obj. č. 11202103</p> 	<ul style="list-style-type: none"> • Mini electronic doorstrike series 5 - with mechanical blocking • electric opener designed for door frame installation • intended for such narrow profiles as aluminum, wood or PVC in particular • short sheet metal front cover version (130 mm) • 16 mm width
<p>obj. č. 11202103-L</p> 	<ul style="list-style-type: none"> • Mini electronic doorstrike series 5 - with mechanical blocking, long • electric opener designed for door frame installation • intended for such narrow profiles as aluminum, wood or PVC in particular • long sheet metal front cover version (250 mm) • 16 mm width

<p>obj. č. 11202104</p> 	<ul style="list-style-type: none"> • Mini electronic doorstrike series 5 - door signaling • electric opener designed for door frame installation • intended for such narrow profiles as aluminum, wood or PVC in particular • including a door state monitoring micro switch: open/ closed • short sheet metal front cover version (130 mm) • 16 mm width
<p>obj. č. 11202104-L</p> 	<ul style="list-style-type: none"> • Mini electronic doorstrike series 5 - door signaling, long • electric opener designed for door frame installation • intended for such narrow profiles as aluminum, wood or PVC in particular • including a door state monitoring micro switch: open/ closed • long sheet metal front cover version (250 mm) • 16 mm width
<p>obj. č. 11202105</p> 	<ul style="list-style-type: none"> • Mini electronic doorstrike series 5 - fail-safe • electric opener designed for door frame installation • intended for such narrow profiles as aluminum, wood or PVC in particular • under voltage: opener secured, blocked • at voltage interruption: opener unblocked, door can be opened • short sheet metal front cover version (130 mm) • 16 mm width

<p>obj. č. 11202105-L</p> 	<ul style="list-style-type: none"> • Mini electronic doorstrike series 5 - fail-safe, long • electric opener designed for door frame installation • intended for such narrow profiles as aluminum, wood or PVC in particular • under voltage: opener secured, blocked • at voltage interruption: opener unblocked, door can be opened • long sheet metal front cover version (250 mm) • 16 mm width
<p>obj. č. 11202106</p> 	<ul style="list-style-type: none"> • Mini electronic doorstrike series 5 - fail-safe and door signaling • electric opener designed for door frame installation • intended for such narrow profiles as aluminum, wood or PVC in particular • under voltage: opener secured, blocked • at voltage interruption: opener unblocked, door can be opened • short sheet metal front cover version (130 mm) • 16 mm width
<p>obj. č. 11202106-L</p> 	<ul style="list-style-type: none"> • Mini electronic doorstrike series 5 - fail-safe and door signaling, long • electric opener designed for door frame installation • intended for such narrow profiles as aluminum, wood or PVC in particular • under voltage: opener secured, blocked • at voltage interruption: opener unblocked, door can be opened • long sheet metal front cover version (250 mm) • 16 mm width

<p>obj. č. 11202201</p> 	<ul style="list-style-type: none"> • Electromechanical lock SAM 7255 • 72/55 self-locking lock with panic function • A key is necessary for door opening from the outside (or an electric pulse from a connected 2N IP intercom / reader). • convenient solution for emergency exits
<p>obj. č. 11202201-M</p> 	<ul style="list-style-type: none"> • Electromechanical lock SAM 7255 with monitoring • 72/55 self-locking lock with panic function • A key is necessary for door opening from the outside (or an electric pulse from a connected 2N IP intercom / reader). • convenient solution for emergency exits
<p>obj. č. 11202202</p> 	<ul style="list-style-type: none"> • Electromechanical lock SAM 9235 • 92/35 self-locking lock with panic function • A key is necessary for door opening from the outside (or an electric pulse from a connected 2N IP intercom / reader). • convenient solution for emergency exits

<p>obj. č. 11202202-M</p> 	<ul style="list-style-type: none"> • Electromechanical lock SAM 9235 with monitoring • 92/35 self-locking lock with panic function • A key is necessary for door opening from the outside (or an electric pulse from a connected 2N IP intercom / reader). • convenient solution for emergency exits
<p>obj. č. 11202301</p> 	<ul style="list-style-type: none"> • Cable protector FX290 • Provides secure passage and protection of the supply cable between the door frame and the door leaf. • 290 mm length
<p>obj. č. 11202302</p> 	<ul style="list-style-type: none"> • Cable protector FX510 • Provides secure passage and protection of the supply cable between the door frame and the door leaf. • 510 mm length

obj. č. 11202303



- **Cable protector FX300G**
- Provides secure passage and protection of the supply cable between the door frame and the door leaf.
- 440 mm length

obj. č. 11202304



- **Cable protector FX500G**
- Provides secure passage and protection of the supply cable between the door frame and the door leaf.
- 640 mm length

obj. č. 11202107



- **Maglock MEX100**
- used as a door holding supplement, not replacing the lock
- consists of two parts: supplied part and counterpart
- under voltage: door cannot be opened
- at voltage interruption: magnets get disconnected, door opens

obj. č. 11202501



- **Magnetic handle P300RP**
- fully replaces a mortise lock and handle
- under voltage: door cannot be opened
- at voltage interruption: magnets get disconnected, door opens
- suitable for wooden, metal and glass doors

obj. č. 11202401



- **ED100**
- low energy simple door operator
- contactless operation
- can be interconnected with a motion sensor and electronic access control system
- applicable for right / left doors
- in / out opening versions

✓ **Tip**

- FAQ: [Electric locks – Difference between locks in 2N IP intercoms accessories](#)

Power Supply



<p>Part Numbers:</p> <p>2N Part No. 91378100E</p> <p>2N Part No. 91378100US</p> <p>Axis Part No. 01403-001</p> 	<ul style="list-style-type: none"> • PoE injector – with EU cable • PoE injector – with US cable • For power supply of intercom via ethernet cable when PoE switch is not available.
<p>Part No. 91341481E</p> 	<ul style="list-style-type: none"> • Adapter 12 V / 2 A • A stabilised power supply has to be used if the Ethernet (PoE) power supply is not available.
<p>Part No. 932928</p> 	<ul style="list-style-type: none"> • 12 V transformer • For 230 V mains voltage. • For external power supply of the lock with 12 V AC voltage.

Two-wire connection

<p>Part numbers:</p> <p>2N Part No. 9159014EU</p> <p>2N Part No. 9159014US</p> <p>Axis Part No. 01404-001</p> <p>2N Part No. 9159014UK</p> 	<ul style="list-style-type: none"> • 2N® 2Wire • set of 2 adaptors and power source for EU/US/UK • The 2N® 2Wire converter allows you to use existing wiring (2 wires) from your original door bell or door intercom to connect any IP device. You don't have to configure anything, and you only need one 2N® 2Wire unit at each end of the cable and a power source connected to at least one of these units. <p>The 2N® 2Wire unit then provides PoE power not only to the second converter, but also to all other connected IP end devices.</p>
-----------------------------------------------------------------------------------------------------------------------------------------------------------------------------------------------------------------------------------------------------------------	------------------------------------------------------------------------------------------------------------------------------------------------------------------------------------------------------------------------------------------------------------------------------------------------------------------------------------------------------------------------------------------------------------------------------------------------------------------------------------------------------------------------------------------------------------------------------------------------------------------



External switches

<p>2N Part No. 9159010</p> <p>Axis Part No. 01386-001</p> 	<ul style="list-style-type: none"> • 2N® Security Relay • A handy add-on that significantly enhances door entry security as it prevents tampering with the intercom and forced opening of the lock. To be installed between intercom and lock, powered by the intercom.
-------------------------------------------------------------------------------------------------------------------------------------------------------------	--------------------------------------------------------------------------------------------------------------------------------------------------------------------------------------------------------------------------------------------------------------------------------------------------------

<p>2N Part No. 9137410E</p> <p>Axis Part No. 01397-001</p> 	<ul style="list-style-type: none"> • External IP Relay – 1 output • Standalone IP device which can be controlled by HTTP commands sent by 2N IP intercom, which can thus control devices on unlimited distance.
<p>2N Part No. 9137411E</p> <p>Axis Part No. 01398-001</p> 	<ul style="list-style-type: none"> • External IP Relay – 4 outputs, PoE • Standalone IP device which can be controlled by HTTP commands sent by 2N IP intercom, which can thus control devices on unlimited distance.

Sensors and switches

<p>Part No. 9159013</p> 	<ul style="list-style-type: none"> • Exit button • A button for connection to a logic input for opening a door inside a building.
--------------------------------------------------------------------------------------------------------------------	-----------------------------------------------------------------------------------------------------------------------------------------------------------

<p>2N Part No. 9154004 Axis Part No. 01479-001</p> 	<ul style="list-style-type: none"> • Water-proof metal button • Hole diameter 19 mm, button diameter 22 mm.
<p>2N Part No. 9159012 Axis Part No. 01388-001</p> 	<ul style="list-style-type: none"> • Magnetic door contact • Set for installation on a door, enabling the status of door opening to be ascertained. Used when the intercom is used for door protection, to detect when the door is not closed or forced open.

Audio accessories

<p>2N Part No. 9154001 Axis Part No. 02570-001</p> 	<ul style="list-style-type: none"> • Electret microphone with self-adhesive layer. • Sensitivity 42 dB, operating temperature 5–35 °C. • Adhesion surface 25 (W) x 25 (H) x 16 (D) mm. • Cable length 2.9 m. • Must be protected from water penetration.
----------------------------------------------------------------------------------------------------------------------------------------------------------	-------------------------------------------------------------------------------------------------------------------------------------------------------------------------------------------------------------------------------------------------------------------------------------------------------------

<p>2N Part No. 9154002</p> <p>Axis Part No. 02571-001</p> 	<ul style="list-style-type: none"> • Speaker with self-adhesive layer. • External dimensions 60 (W) x 60 (H) x 14 (D) mm, actual speaker diameter 45 mm. • Cable length 1.4 m. • Must be protected from water penetration. <ul style="list-style-type: none"> • Impedance: 16 ohm +/- 15% • Power: 1 W
-----------------------------------------------------------------------------------------------------------------------------------------------------------	---------------------------------------------------------------------------------------------------------------------------------------------------------------------------------------------------------------------------------------------------------------------------------------------------------------------------------------------------------------------------------------

License

<p>2N Part No. 9137905</p>	<ul style="list-style-type: none"> • Enhanced Audio
<p>2N Part No. 9137906</p>	<ul style="list-style-type: none"> • Enhanced Video
<p>2N Part No. 9137907</p>	<ul style="list-style-type: none"> • Enhanced Integration
<p>2N Part No. 9137908</p>	<ul style="list-style-type: none"> • Enhanced Security
<p>2N Part No. 9137909</p>	<ul style="list-style-type: none"> • Gold

<p>2N Part No. 9137910</p> <p>Axis Part No. 01381-001</p>	<ul style="list-style-type: none">• InformaCast
<p>2N Part No. 9137915</p>	<ul style="list-style-type: none">• NFC

✓ **Tip**

- Refer to the Configuration Manual for 2N IP intercoms, Subs. [3.2 Function Licensing](#) for details.

✓ **Tip**

- For more accessories and particular advice please contact your local distributor of 2N products.

1.2 Terms and Symbols

The following symbols and pictograms are used in the manual:

⚠ **Safety**

- **Always abide** by this information to prevent persons from injury.

⚠ **Warning**

- **Always abide** by this information to prevent damage to the device.

⚠ **Caution**

- **Important information** for system functionality.

✓ **Tip**

- **Useful information** for quick and efficient functionality.

i **Note**

- Routines or advice for efficient use of the device.

2. Description and Installation

Here is what you can find in this section:

- [2.1 Before You Start](#)
- [2.2 Mechanical Installation](#)
- [2.3 Electric Installation](#)
- [2.4 Extending Module Connection](#)
- [2.5 Configuration](#)
- [2.6 Downloads](#)

2.1 Before You Start

Product Completeness Check

Before installing this product, please check whether the **2N® IP Audio Kit** delivery complies with the following packing list.

- 1x **2N® IP Audio Kit**
- 1x Short Installation Manual

2.2 Mechanical Installation

Mounting Types

Refer to the table below for a list of mounting types and necessary components. Make sure that the installation site is not exposed to flowing or condensed water.

Caution

- Before starting the mechanical installation on a selected place, make sure carefully that the preparations connected with it (drilling, wall cutting) cannot damage the electrical, gas, water and other existing wires and pipes.

Wall mounting

Use the proper wall mounting screws and dowels (not included in the delivery). Hang the device on the wall using the cover bottom holes.

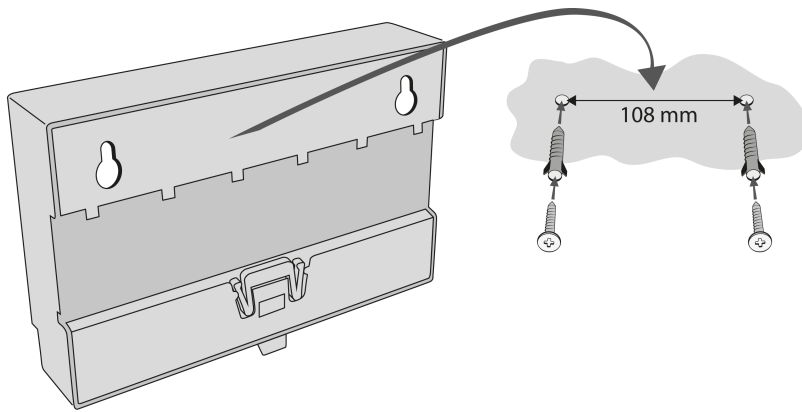

DIN rail mounting

Mount the device to a standard TS 35 DIN rail. The recommended minimum DIN rail length is 14 cm.

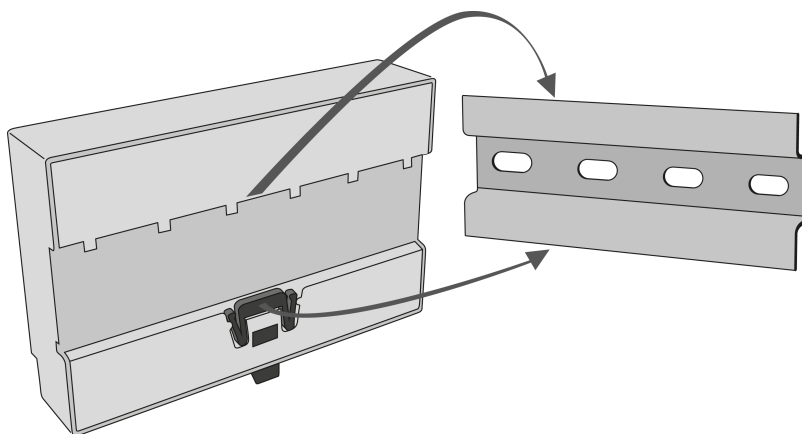

PCB mounting (for Part No. 9154101 only)

Use 4–6 distance columns and proper screws (not included in the delivery) to mount the PCB to the support. Fix the distance columns as shown in the figure.

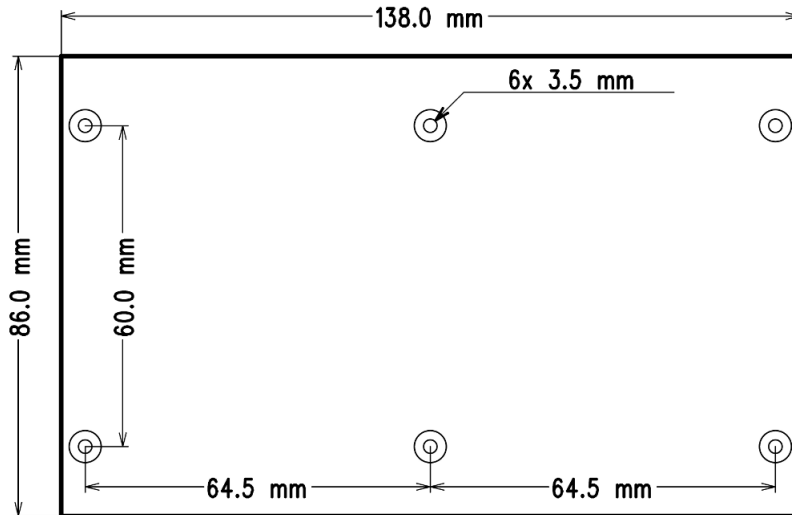

⚠ Caution

- The warranty does not apply to the product defects and failures arisen as a result of improper mounting (in contradiction herewith). The manufacturer is neither liable for damage caused by theft within an area that is accessible after the attached electric lock is switched. The product is not designed as a burglar protection device except when used in combination with a standard lock, which has the security function.
- Device is for indoor use only. When the proper mounting instructions are not met, water might get in and destroy the electronics. It is because the intercom circuits are under continuous voltage and water infiltration causes an electro-chemical reaction. The manufacturer's warranty shall be void for products damaged in this way!
- To avoid injury due to accidental drop of the equipment, do not mount it higher than 2 meters.

2.3 Electric Installation

This subsection describes how to connect the **2N® IP Audio Kit** into your Local Area Network (LAN) and how to connect supply voltage and other electric interfaces.

⚠ Warning

- Do not connect any power until the assembly and installation are complete.

Device and PCB Connectors

The figures below show the layout of the **2N® IP Audio Kit** and **2N® IP Audio Kit Lite** connectors and terminals.



Version R394-1



Version R345v2



Connectors

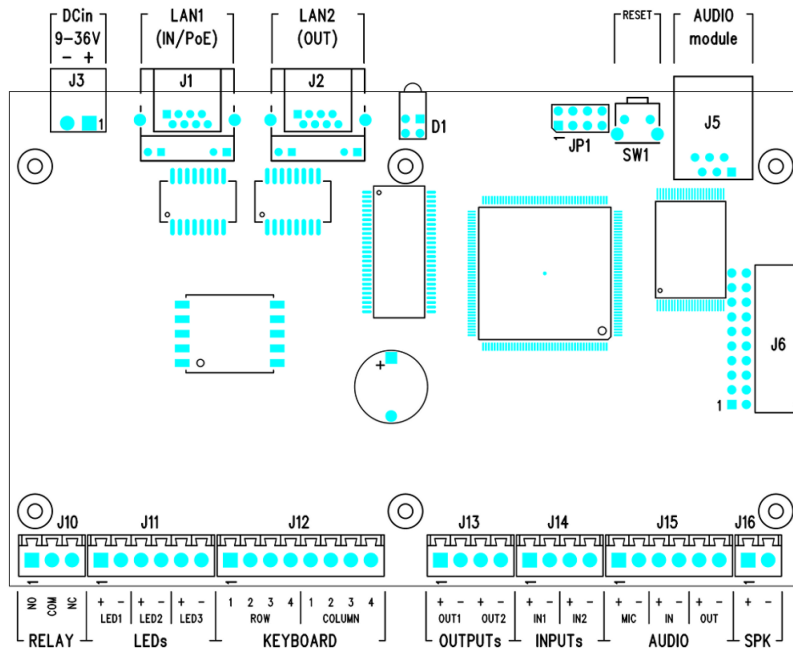

PCB Connectors

Legend to figures

Group	Terminals	Function
DC in		Power input 9 to 26 V ± 10 % / 2 A DC, typically 12 V DC
LAN1		LAN connection with PoE function, not available at Lite version
LAN2		LAN connection, available only for R345v2 version, not available at Lite version
LAN		Only at Lite version, LAN connection
D1		Integrated red and green LED indicators, not available at Lite version
RESET		RESET multifunction button

AUDIO MODULE		Connection of an audio module with microphone, loudspeaker, buttons and LEDs
RELAY	NO, COM, NC	Programmable relay switch with an accessible N/O and N/C contact. Used for connection of non-critical devices only (lights, e.g.).
LEDs	LED1+, LED1- LED2+, LED2- LED3+, LED3-	3 current outputs for connection of programmable LED indicators; two terminals per LED, not available at Lite version
KEYBOARD	COL1-4 ROW1-4	Connection of matrix keypad (4 x 4) or 16 separate buttons, not available at Lite version
BUTTON		Only at Lite version, a button is mapped to pins COL1 ROW4. This position is mapped to sign * by default. Refer to the section Connection of Keypad/Buttons.
OUTPUTS	OUT1+, OUT1- OUT2+, OUT2-	2 programmable active outputs (supply from PoE: 10 V DC; suply from external source: voltage minus 2 V, max. 11 V DC) output current: Max. 600 mA, not available at Lite version
INPUTs	IN1+, IN1- IN2+, IN2-	2 programmable galvanically isolated inputs, not available at Lite version
AUDIO	MIC+, MIC- IN+, IN- OUT+, OUT-	Microphone input line input, not available at Lite version line output, not available at Lite version
SPEAKER	SPK+, SPK-	Power amplifier output for loudspeaker

Connection to LAN

Connect **2N® IP Audio Kit** to the LAN using an RJ-45 terminated UTP/STP cable (of category Cat 5e or higher). As the device is equipped with the Auto-MDIX function, you can use either the straight or crossed cable version.

2N® IP Audio Kit is according to the version equipped with one or two LAN interfaces (LAN1 and LAN2) and an integrated Ethernet switch. You can use only LAN1 interfaces for LAN connection. LAN1 is the only interface provided with PoE.

LAN2 helps connect another LAN device on the installation site. This interface is not equipped with PoE.

Note

- **2N® IP Audio Kit** does not allow you to feed another connected device via PoE. The integrated PoE function is intended for the **2N® IP Audio Kit** supply only.

Caution

- We recommend the use of a LAN surge protection.
- We recommend the use of a shielded SSTP Ethernet cable.

Connection of External Power Supply

2N® IP Audio Kit can be supplied either from an external 9–26 V / 2 A DC source or directly from the LAN provided with the PoE 802.3af supporting network elements.

External Power Supply

Connect the external 12 V power supply to the DC in terminals. Use safety low-voltage voltage (SELV, 9–26 V) dimensioned for the minimum current consumption of 2 A (Part No. 91341481E, e.g.) to make your device work correctly.

PoE Supply

2N® IP Audio Kit is compatible with the PoE 802.3af technology (Class 0–12.95 W) and can be supplied directly from the LAN via compatible network elements. If your LAN lacks such compatible elements, you can insert a PoE injector, Part No. 91758100E, between your **2N® IP**

Audio Kit and the nearest network element. Connect your **2N® IP Audio Kit** to the LAN via the LAN1 interface to supply it successfully.

 **Caution**

- In case you feed your **2N® IP Audio Kit** via PoE or from a limited-power external power supply, monitor the power consumption of the whole system. With regard to the PoE 802.3af capacities and efficiency of the switched-mode power supplies in the device, the maximum possible device input is approximately 12 W. An overload of the PoE source usually results in PoE disconnection and, subsequently, **2N® IP Audio Kit** restart.
- The **2N® IP Audio Kit** consumption at relax (power amplifier inactive, no load switched on LED1–3 and OUT1–2 outputs) is up to 2 W.
- The maximum power amplifier consumption is determined by the current loudspeaker volume level and impedance (up to 10 W for a 4 Ω loudspeaker). The real consumption is typically lower and depends on the characteristics of the signal to be amplified.
- If you intend to connect a considerable load to the OUT1 and OUT2 outputs, make sure that the total input does not exceed the above mentioned limit (12 W for PoE). If the PoE supply fails to provide sufficient power for the specific application, use a more powerful external source to make your device work perfectly.

Connection of LED Indicators

2N® IP Audio Kit is equipped with three independent current LED control outputs (LED1±, LED2± and LED3± terminals). All of them are current outputs (20 mA, up to 12 V). You can connect the LEDs directly to the terminals of these outputs or use LEDs with serial resistors. Mind the polarity while connecting the LEDs to make your device work properly.

The functions of the LED1, LED2 and LED3 outputs are programmable.

Connection of Keypad/Buttons

2N® IP Audio Kit is equipped with an interface for connection of an external matrix keypad or up to 16 separate buttons; see the figure below:

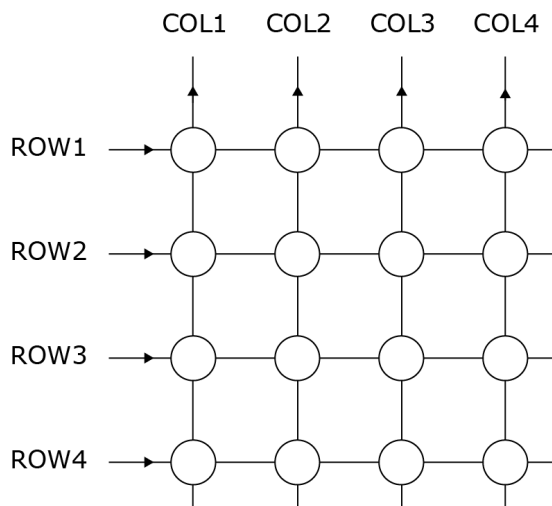

The buttons are connected in a 4 × 4 matrix to the ROW1–4 (output) and COL1–4 (inputs) terminals. If you do not make use of all of the 16 buttons, you can leave some of the ROW and COL signals unconnected. If you need one button only, connect it to the ROW1 and COL4 terminals.

The button function is programmable. You can set the numerical keypad buttons to any matrix position (0 to 9, *, #) or configure one of the 16 buttons for dialling a telephone directory position.

⚠ Caution

- Errors such as false keystroke detection may occur in installations with strong EMI. Therefore, make sure that the keypad or button cables are carried in a trunk separated from the power cables and are as short as possible (up to 1 m).



- Lite version has a button (BUTTON) connected to the terminals COL1, ROW4. In a default configuration, a keypad button * is configured at this matrix position.

Connection of External Loudspeaker

2N® IP Audio Kit is equipped with an integrated 10 W power amplifier of class D. The amplifier output is available on the SPEAKER+ and SPEAKER- terminals. The maximum power is achievable with a 4 Ω loudspeaker only.

The higher the loudspeaker impedance, the lower the maximum power output; refer to the table below:

Loudspeaker impedance	Maximum power (at +20 dB)
4 Ω (min)	10 W
8 Ω	5 W
16 Ω	2.5 W
32 Ω	1.2 W
64 Ω	0.6 W

⚠ Caution

- Never connect a loudspeaker with impedance lower than 4 Ω to avoid system damage.
- Never exceed the maximum power output designated for the loudspeaker to avoid loudspeaker destruction. Choose a loudspeaker with proper impedance and maximum power values, or limit the maximum volume level in the device configuration.
- Use an external power supply to maximise the power output. Make sure that the maximum Master volume value is +6 dB in the Hardware / Audio menu if you use PoE and 4 Ω speaker.

Connection of External Microphone

2N® IP Audio Kit is equipped with an input for connection of an external electret microphone on the MIC+ and MIC- terminals. Shielding of the shielded cable is connected to the IN- terminal.

⚠ Caution

- Undesired noise may be heard in the earphone where EMI affects the microphone signal. To avoid this, connect the microphone using a shielded cable of the minimum possible length.
- If you use a one-conductor shielded wire, interconnect the MIC- and IN- terminals.

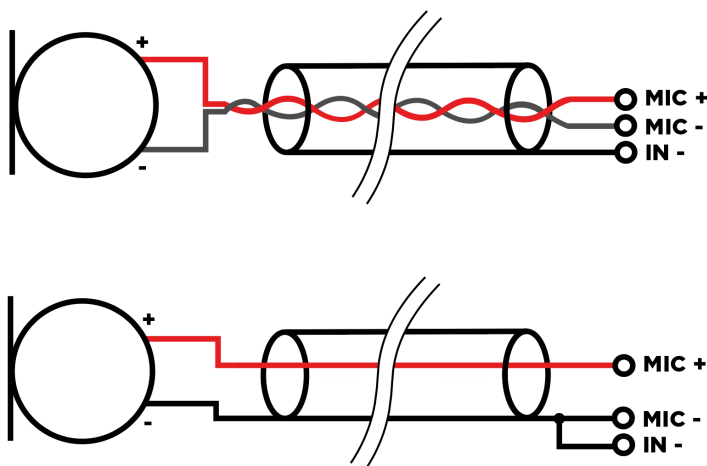

Connection of External Amplifier

2N® IP Audio Kit is equipped with a line output for connection of an external power amplifier on the LINE OUT+ and LINE OUT- terminals.

Connection of External Audio Source

2N® IP Audio Kit is equipped with a line input for connection of an external audio signal source (FM tuner, MP3 player, e.g.) on the LINE IN+ and LINE IN- terminals.

Connection to Relay Output

2N® IP Audio Kit is equipped with one galvanically isolated relay switch with N/O and N/C contacts on the NC, NO and COM terminals. The relay function is programmable.

✓ **Tip**

- Output wiring diagram for Relay terminals

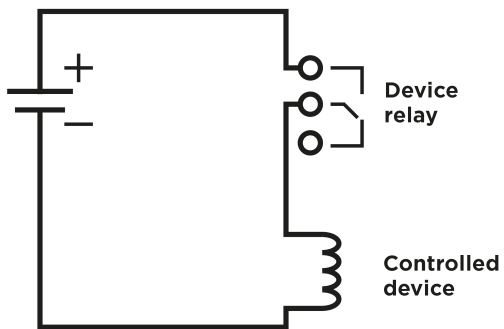

Wiring diagram for the controlled device electric circuit closing

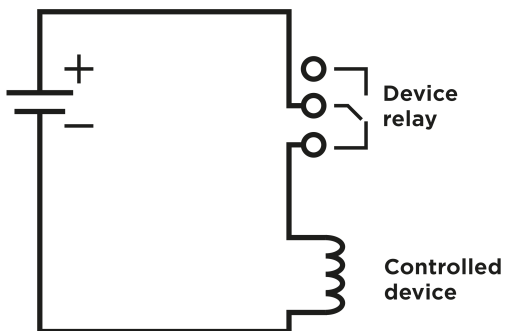

Wiring diagram for the controlled device's electric circuit opening

⚠ **Warning**

- Do not exceed the voltage and current limits for the load connected to the relay contacts as specified in the technical parameters of the device to avoid device damage.

Reset Button

Located among the main unit connectors, the Reset button helps you reset the factory default values, restart the device, find the device IP address and switch the static/dynamic mode.

IP Address Finding

Follow the instructions below to **identify the current IP address**:

- Press and hold the RESET button.
- Wait until the red and green LEDs go on simultaneously on the device and the acoustic signal  can be heard (approx. 15–35 s).
- Release the RESET button.
- The device automatically announces the current IP address.

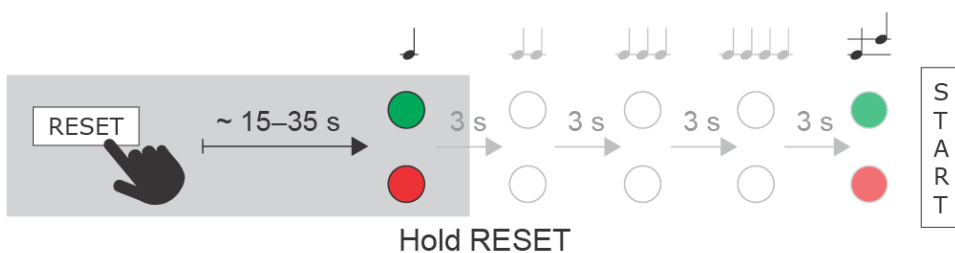



Note

- The delay after pressing RESET till the first light and sound signalling is set to 15–35 s depending on the 2N IP intercom/answering unit model used.
 - 37 s is the valid value for 2N® IP Audio Kit.

Static IP Address Setting

Follow the instructions below to switch on the **Static IP address** mode (DHCP OFF):

- Press and hold the RESET button.
- Wait until the red and green LEDs go on simultaneously on the device and the acoustic signal  can be heard (approx. 15–35 s).

- Wait until the red LED goes off and the acoustic signal  can be heard (approx. for another 3 s).
- Release the RESET button.

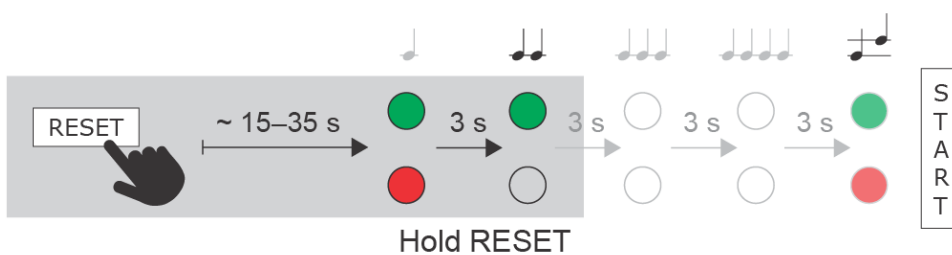

The following network parameters will be set after restart:

- IP address: 192.168.1.100
- Network mask: 255.255.255.0
- Default gateway: 192.168.1.1



Dynamic IP Address Setting



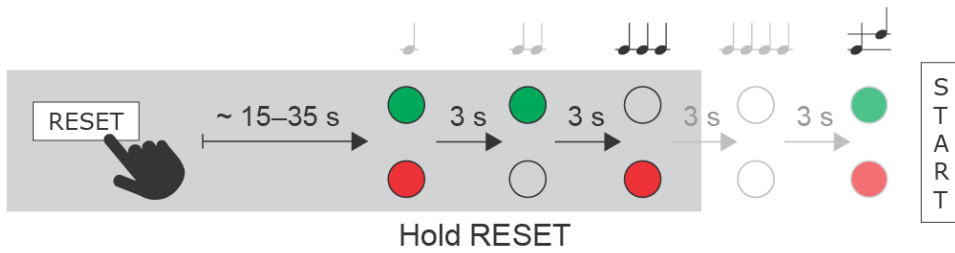

Follow the instructions below to switch on the **Dynamic IP address** mode (DCHP ON):

- Press and hold the RESET button.
- Wait until the red and green LEDs go on simultaneously on the device and the acoustic signal  can be heard (approx. 15–35 s).
- Wait until the red LED goes off and the acoustic signal  can be heard (approx. for another 3 s).
- Wait until the green LED goes off and the red LED goes on again and the acoustic signal  can be heard (approx. for another 3 s).
- Release the RESET button.



Factory Reset

Follow the instructions below to **reset the factory default values**:

- Press and hold the RESET button.
- Wait until the red and green LEDs go on simultaneously and the acoustic signal  can be heard (approx. 15–35 s).
- Wait until the red LED goes off and the acoustic signal  can be heard (approx. for another 3 s).
- Wait until the green LED goes off and the red LED goes on again and the acoustic signal  can be heard (approx. for another 3 s).
- Wait until the red LED goes off and the acoustic signal  can be heard (approx. for another 3 s).
- Release the RESET button.

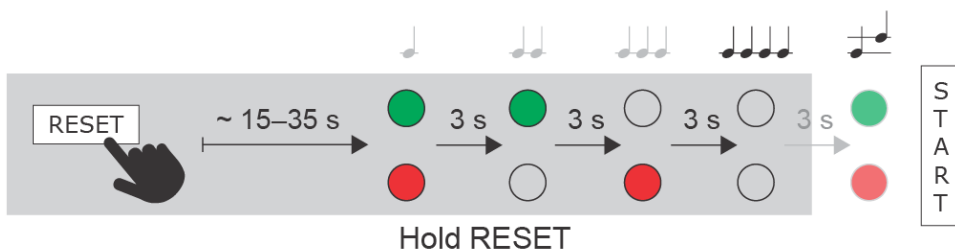

⚠ Caution

- In case of resetting the factory default settings on a device with a version of firmware 2.18 or higher it is necessary to reprogram the **2N® Security Relay** using the instructions from section 2.4.

Device Restart

Press the RESET button shortly (< 1 s) to restart the system without changing configuration.

i Note

- The time interval between the short press of RESET and reconnection after restart is 47 s for **2N® IP Audio Kit**.

Connection to Digital Outputs

2N® IP Audio Kit is equipped with two active outputs (supply from PoE: 10 V DC; supply from external source: voltage minus 2 V, max. 11 V DC, output current: max 600 mA) on the OUT1± and OUT2± terminals. The outputs are overload and short-circuit resistant. The output function is programmable.

⚠ Warning

When you connect a device containing a coil, such as a relay or an electromagnetic lock, it is necessary to protect the intercom against voltage peak while switching off the induction load. For this way of protection we recommend a diode 1 A / 1000 V (e.g., 1N4007, 1N5407, 1N5408) connected antiparallel to the device.

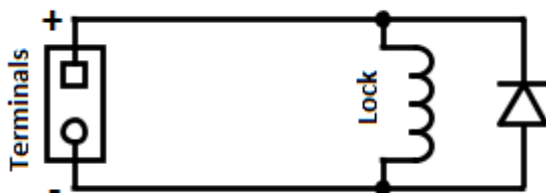

Connection to Digital Inputs

2N® IP Audio Kit is equipped with two digital inputs on the IN1± and IN2± terminals. The digital inputs recognise the following two logic levels: log. 0 for voltage under 1.1 V a log. 1 for voltage over 3 V. Keep the voltage polarity to make the function work properly. The function is programmable for either input.

2.3.1 Overvoltage Protection

Recommendations for Additional Overvoltage Protection Installation

If running:

- a) outside a building,
- b) on/in an outer wall or roof,

the 2N device wiring may be exposed to atmospheric effects resulting in overvoltage that may subsequently damage any devices installed outside the building, on its outer wall or roof. Overvoltage may damage devices connected to these wires and installed inside the building as well. Therefore, we recommend that additional surge protectors be installed on all the wires leading outside buildings, on outer walls or roofs, namely:

- a) as close as possible to the device installed outside the building or on its outer wall/roof,
- b) as close as possible to the point where the wires leave the building.

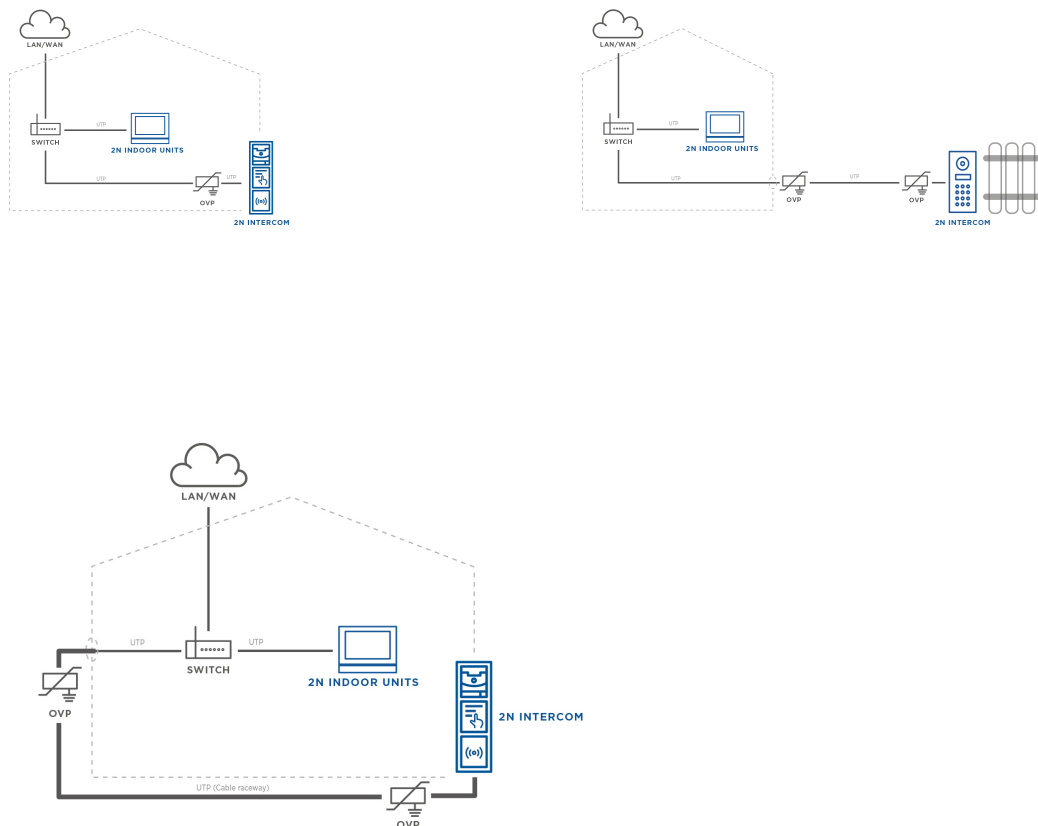

OVP = overvoltage protection

2.4 Extending Module Connection

2N® IP Audio Kit allows to connect following extending modules:

- Security Relay

Security Relay

The **Security Relay** (Part No. 9159010) is used for enhancing security between the intercom and the connected electric lock. The **2N® Security Relay** is designed for any **2N IP** intercom model with firmware versions 1.15 and higher. It significantly enhances security of the connected electric lock as it prevents lock opening by forced intercom tampering.



Function:

The **2N® Security Relay** is a device installed between an intercom (outside the secured area) and the electric lock (inside the secured area). The **2N® Security Relay** includes a relay that can only be activated if the valid opening code is received from the intercom.

Specifications:

Passive switch: NO and NC contacts, up to 30 V / 1 A AC/DC

Switched output:

- Where the security relay is fed from the intercom, 9 to 13 V DC is available on the output depending on the power supply (PoE: 9 V; adapter: source voltage of minus 1 V) / 400 mA DC.
- Where the security relay is fed from an external power supply, 12 V / 700 mA DC is available on the output.

Dimensions: (56 x 31 x 24) mm

Weight: 20 g

Installation:

Install the **2N® Security Relay** onto a two-wire cable between the intercom and the electric lock inside the area to be secured (typically behind the door). The device is powered and controlled

via this two-wire cable and so can be added to an existing installation. Thanks to its compact dimensions, the device can be installed into a standard mounting box.

Connection:

Connect the **2N® Security Relay** to the intercom as follows:

- To the intercom active output (OUT1 or OUT2)

Connect the electric lock to the **2N® Security Relay** output as follows:

- To the switched output.
- To the passive output in series with the external power supply.

The device also supports a Departure button connected between the ‘PB’ and ‘- HeliosIP/IP Intercom’ terminals. Press the Departure button to activate the output for 5 seconds.

Status signalling:

Green LED	Red LED	Status
blinking	off	Operational mode
on	off	Activated output
blinking	blinking	Programming mode – waiting for initialisation
on	blinking	Error – wrong code received

Configuration:

- Connect the **2N® Security Relay** to the properly set intercom switch output; refer to the **Configuration Manual for 2N IP intercoms**. Make sure that one LED at least on the **2N® Security Relay** is on or blinking.
- Press and hold the **2N® Security Relay** Reset button for 5 seconds to put the device in the programming mode (both the red and green LEDs are blinking).
- Activate the intercom switch using the keypad, telephone, etc. The first code sent from the intercom will be stored in the memory and considered valid. After code initialisation, the **2N® Security Relay** will pass into the operational mode (the green LED is blinking).

⚠ Caution

- In case of resetting the factory default settings on a device with a version of firmware 2.18 or higher it is necessary to reprogram the **2N® Security Relay** using the instructions above.

✔ Tip

- [FAQ: 2N® Security Relay – what it is and how to use it with 2N IP intercom?](#)

Connection:

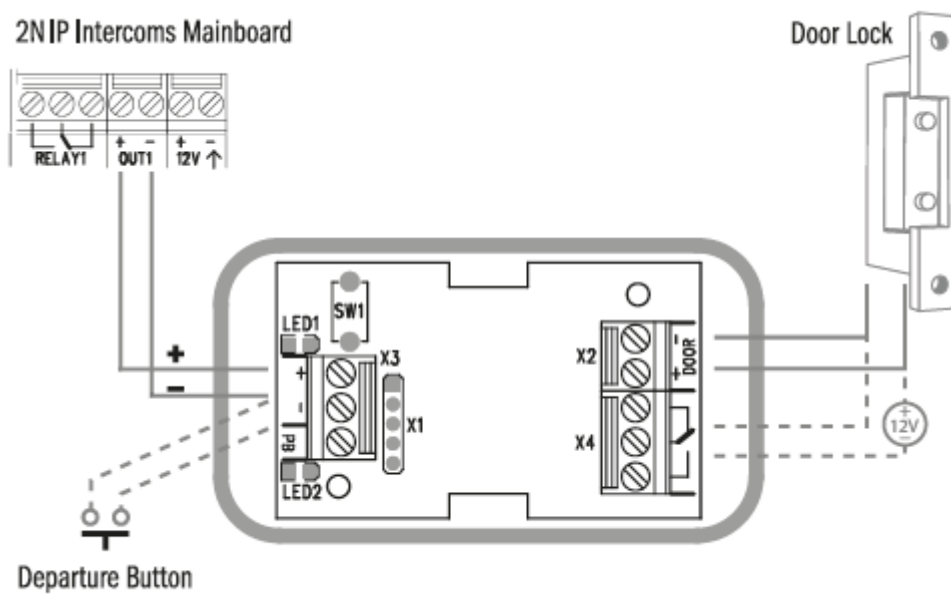

✔ Tip

Video Tutorial: Security Relay Installation and Configuration



Sorry, the widget is not supported in this export.
But you can reach it using the following URL:
<https://www.youtube.com/watch?v=ardukvQzw5A>

2.5 Configuration

Device Configuration

Configure **2N® IP Audio Kit** using a PC equipped any web browser as follows:

- Launch your web browser (Internet Explorer, Firefox, etc.).
- Enter the IP address of your intercom (<http://192.168.1.100/>, e.g.).
- Log in with username **Admin** and password **2n**.

You have to know the IP address of your device to log in to the integrated web server. Upon purchase, **2N® IP Audio Kit** is in the Dynamic IP address mode, i.e. it obtains the IP address automatically if there is an adequately set DHCP server in the LAN. If no such server is available, set the Static IP address mode to your **2N® IP Audio Kit**.

If the device remains inaccessible (you have forgotten the IP address or the LAN configuration has changed, e.g.), change the network settings using the RESET button on the device. For more information see chapter [2.3 Electric Installation](#).

2.6 Downloads

Software

[2N® Network Scanner](#)

3. Technical Parameters

Supported Protocols

- **LAN interface:** IPv4, ARP, TCP, UDP, DHCP
- **Device configuration:** HTTP/HTTPS
- **Call signalling:** SIP 2.0 (UDP, TCP, TLS)
- **Audio data transmission:** RTP (G.711)
- **Audio streaming:** RTSP
- **Time synchronisation:** SNTP
- **Auto provisioning:** TFTP
- **E-mail sending:** SMTP

Power Supply

- **External power supply:** 9 to 26 V \pm 10 % / 2 A DC or PoE, typically 12 V DC
- **PoE:** 802.3af (Class 0 – up to 12.95 W)
- **Power consumption:** 2 W at relax

LAN Interface

- **LAN interface count:** 1 (since HW version R394-1)
- **PoE:** 802.3af
- **Parameters:** 10/100BASE-TX with Auto-MDIX, RJ-45
- **Recommended cabling:** Cat-5e or higher

Audio Interface

- **Microphone input:** Standard electret microphone, Max. Vpp = 100 mV, Rin = 4.4 k Ω , Vbias = 1.5 V
- **Line input:** Max. 755 mV RMS, Rin = 47 k Ω
- **Amplifier output:** 10 W amplifier of class D, MONO output, THD < 1%, minimum loudspeaker impedance: 4 Ω
- **Line output:** Max. 755 mV RMS, Rout = 600 Ω
- **Acoustic echo cancelling:** AEC, full duplex

Bandwidth

- **Audio codecs**
 - PCMA, PCMU – 64 kbps (with 85.6 kbps headers)

Button/Keypad Interface

- **Button count:** Up to 16 separate buttons in 4x4 matrix
- **Button function:** User programmable
- **Matrix outputs:** 4 (ROW1–4 terminals) Uout < 0.1 V (L), Uout > 3.2 V (H), up to 8 mA
- **Matrix inputs:** 4 (COL1–4 terminals) Uin < 1.15 V (L), Uin > 2.15 V, max. Uin = 5 V

LED Control Outputs

- **Output count:** 3 (LED1 \pm , LED2 \pm and LED3 \pm terminals)

- **Output function:** User programmable
- **Output current:** Typ. 20 mA
- **Output voltage:** Up to 12 V

Digital Outputs

- **Output count:** 2 (OUT1± and OUT2± terminals)
- **Output function:** User programmable
- **Output type:** Power output with short-circuit protection
- **Output voltage**
 - PoE power supply: 10 V DC
 - External power supply: Power supply voltage minus 2 V, maximum 11 V DC
- **Output current:** Up to 600 mA

Digital Inputs

- **Input count:** 2 (IN1± and IN2± terminals)
- **Input function:** User programmable
- **Input type:** Galvanically isolated inputs (opto-couplers)
- **Characteristics:** $U_{in} < 1.1 \text{ V (L)}$, $U_{in} > 3 \text{ V (H)}$, max. $U_{in} = 32 \text{ V}$

Relay Output

- **Output count:** 1 (NC, NO, COM terminals)
- **Output function:** User programmable
- **Limits (DC):** Up to 30 V DC / 1 A
- **Limits (AC):** Up to 50 V AC / 0.3 A

Mechanical Properties

- **Working temperature:** -40 °C – 55 °C
- **Working relative humidity:** 10 % – 95 % (non-condensing)
- **Maximum altitude for intended use:** 2000 m a.s.l.
- **Storing temperature:** -40 °C – 70 °C
- **Dimensions:** (142 x 98 x 34) mm (Part No. 9154100), (138 x 90 x 26) mm (Part No. 9154101)
- **Weight:** Up to 280 g (Part No. 9154100), Up to 150 g (Part No. 9154101)
- **Protection class:** IP20 (Part No. 9154100), IP00 (Part No. 9154101)

Note

- If you feed the device from a DC power source and the supply voltage is lower than 12 V, then the output voltage is limited to the supply voltage value.

4. Supplementary Information

Here is what you can find in this section:

- [4.1 Troubleshooting](#)
- [4.2 Directives, Laws and Regulations](#)
- [4.3 General Instructions and Cautions](#)

4.1 Troubleshooting



For the most frequently asked questions refer to faq.2n.cz.

4.2 Directives, Laws and Regulations

2N® IP Audio Kit conforms to the following directives and regulations:

- 2014/35/EU for electrical equipment designed for use within certain voltage limits
- 2014/30/EU for electromagnetic compatibility
- 2011/65/EU on the restriction of the use of certain hazardous substances in electrical and electronic equipment
- 2012/19/EU on waste electrical and electronic equipment

Industry Canada

This Class B digital apparatus complies with Canadian ICES-003/NMB-003.

FCC

This equipment has been tested and found to comply with the limits for a Class B digital device, pursuant to part 15 of the FCC Rules.

NOTE: These limits are designed to provide reasonable protection against harmful interference in a residential installation. This equipment generates, uses and can radiate radio frequency energy and, if not installed and used in accordance with the instructions, may cause harmful interference to radio communications.

However, there is no guarantee that interference will not occur in a particular installation. If this equipment does cause harmful interference to radio or television reception, which can be determined by turning the equipment off and on, the user is encouraged to try to correct the interference by one or more of the following measures:

- Reorient or relocate the receiving antenna
- Increase the separation between the equipment and receiver
- Connect the equipment into an outlet on a circuit different from that to which the receiver is connected
- Consult the dealer or an experienced radio/TV technician for help

Changes or modifications to this unit not expressly approved by the party responsible for compliance could void the user's authority to operate this equipment.

⚠ Caution**Warning**

In order to ensure the full functionality and guaranteed performance, we strongly recommend that the topicality of the product / device version in use be verified as early as in the installation process. The customer hereby acknowledges that the product / device can achieve the guaranteed performance and full functionality pursuant to the manufacturer's instructions only if the latest product / device version is used after having been tested for full interoperability and not having been determined by the manufacturer as incompatible with certain versions of other products, and only in conformity with the manufacturer's instructions, guidelines or recommendations and in conjunction with suitable products and devices of other suppliers. The latest versions are available at https://www.2n.com/cs_CZ/ or can be updated via the configuration interface if the devices are adequately technically equipped. Should the customer use a product / device version other than the latest one or a version determined by the manufacturer as incompatible with certain versions of other products, or should the customer use the product / device in contradiction to the manufacturer's instructions, guidelines or recommendations or in conjunction with unsuitable products / devices of other suppliers, the customer is aware of and agrees with all functionality limitations of such a product / device if any as well as with all consequences incurred as a result thereof. Using a product / device version other than the latest one or a version determined by the manufacturer as incompatible with certain versions of other products, or using the product / device in contradiction to the manufacturer's instructions, guidelines or recommendations or in conjunction with unsuitable products / devices of other suppliers, the customer agrees that the 2N TELEKOMUNIKACE a.s. company shall not be held liable for any functionality limitation of such a product or any damage, loss or injury related to this potential functionality limitation.

4.3 General Instructions and Cautions

Please read this User Manual carefully before using the product. Follow all instructions and recommendations included herein.

Any use of the product that is in contradiction with the instructions provided herein may result in malfunction, damage or destruction of the product.

The manufacturer shall not be liable and responsible for any damage incurred as a result of a use of the product other than that included herein, namely undue application and disobedience of the recommendations and warnings in contradiction herewith.

Any use or connection of the product other than those included herein shall be considered undue and the manufacturer shall not be liable for any consequences arisen as a result of such misconduct.

Moreover, the manufacturer shall not be liable for any damage or destruction of the product incurred as a result of misplacement, incompetent installation and/or undue operation and use of the product in contradiction herewith.

The manufacturer assumes no responsibility for any malfunction, damage or destruction of the product caused by incompetent replacement of parts or due to the use of reproduction parts or components.

The manufacturer shall not be liable and responsible for any loss or damage incurred as a result of a natural disaster or any other unfavourable natural condition.

The manufacturer shall not be held liable for any damage of the product arising during the shipping thereof.

The manufacturer shall not make any warrant with regard to data loss or damage.

The manufacturer shall not be liable and responsible for any direct or indirect damage incurred as a result of a use of the product in contradiction herewith or a failure of the product due to a use in contradiction herewith.

All applicable legal regulations concerning the product installation and use as well as provisions of technical standards on electric installations have to be obeyed. The manufacturer shall not be liable and responsible for damage or destruction of the product or damage incurred by the consumer in case the product is used and handled contrary to the said regulations and provisions.

The consumer shall, at its own expense, obtain software protection of the product. The manufacturer shall not be held liable and responsible for any damage incurred as a result of the use of deficient or substandard security software.

The consumer shall, without delay, change the access password for the product after installation. The manufacturer shall not be held liable or responsible for any damage incurred by the consumer in connection with the use of the original password.

The manufacturer also assumes no responsibility for additional costs incurred by the consumer as a result of making calls using a line with an increased tariff.

Electric Waste and Used Battery Pack Handling



Do not place used electric devices and battery packs into municipal waste containers. An undue disposal thereof might impair the environment!

Deliver your expired electric appliances and battery packs removed from them to dedicated dumpsites or containers or give them back to the dealer or manufacturer for environmental-

friendly disposal. The dealer or manufacturer shall take the product back free of charge and without requiring another purchase. Make sure that the devices to be disposed of are complete. Do not throw battery packs into fire. Battery packs may not be taken into parts or short-circuited either.

